

GRAVELY

OWNER'S MANUAL



Gravely Super Tractor, ▲
Steering Sulky, 50-inch Rotary Mower

Gravely Custom Tractor,
Riding Sulky, 30-inch Reel Mower
◀



SOLD BY:

CONTENTS

THE GRAVELY TRACTOR 1

GRAVELY ACCESSORIES

Dual Wheels	5
Attachment Clutch Control	5
Governor	5
Electric Starter	5
Engine Heater	6
Muffle-Tone Silencer	6
Oil Pressure Gauge	6
Extension Axles	6
Tire Chains	6
Dipstick	6
Gear Reduction Wheels	6
Tractor Cover	6

POWER ATTACHMENTS

Attaching to Tractor	7
Safety Clutch	7
20-Gallon Sprayer	7
Power Take-off	8
Sickle Mower	9
50-inch Rotary Mower	10
30-inch Rotary Mower	12
Leaf Mulcher	12
Leaf-Away	12
Chain Saw	13
Circular Saw	13
30-inch Reel Mower	14
25-inch Gang Units	15
Rotary Plow	16
Rotary Cultivator	17
Snowblower	18
Power Brush	19

NON-POWER ATTACHMENTS

Cultivator Tool Holder	20
Scraper Blade	20
48-inch Snowplow	20
Power Barrow	21
Utility Scoop	22
Rear Cultivator Tool Holder	22
Steering Sulky	22
Riding Sulky	22
Disc Harrow	22
Hay Rake	23
Turn Plow	23
Rear Hitch Instructions	23
Lawn Roller	24
Transportation Cart	24
5-foot Seeder-Spreader	24

THE *GRAVELY* TRACTOR

LUBRICATION

ENGINE - CHASSIS - CAPACITY 5 U.S. PINTS
USE ONLY HIGH GRADE LUBRICANTS SUCH AS -

ABOVE 32°F **MOBIL OIL A** (SAE 30)
BELOW 32°F **MOBIL OIL ARCTIC** (SAE 20W)
WITH MACHINE LEVEL - FILL TO "FULL" MARK
ON DIP STICK

FUEL TANK CAPACITY - 2 U.S. GALLONS
FUEL - USE GOOD GASOLINE SUCH AS -
MOBIL REGULAR

ATTACHMENTS - USE GEAR OILS SUCH AS -
SUMMER - **MOBILUBE EP 140** (SAE 140)
WINTER - **MOBILUBE EP 80-90** (SAE 80-90)

READ INSTRUCTION MANUAL CAREFULLY

MODEL NUMBER TRACTOR SERIAL NUMBER

MANUFACTURING NUMBER

MANUFACTURED BY
GRAVELY TRACTORS
DIVISION STUDEBAKER CORPORATION
DUNBAR, WEST VIRGINIA, U.S.A.

THANK YOU

for your investment in Gravelly equipment. It is an investment, for the Gravelly will save you work and worry for many years.

You will gain still greater satisfaction from your powerful Gravelly if you add the tools you need for your other jobs. From time to time we suggest you consult our four-color catalog or this manual for the many Gravelly attachments that will eliminate grounds upkeep and garden drudgery.

Numerous independent dealers and factory branches distribute Gravelly equipment. All are ready to give prompt and efficient service, with parts in stock and personnel trained in factory-service methods.

The Gravelly Tractor and attachments are manufactured by Gravelly, Tractor Division, Studebaker Corporation. Our main factory is at Dunbar, West Virginia.

Your Gravelly Tractor and attachments are warranted under terms shown below. To qualify for this Warranty, you must register your equipment by completing the attached Registration Card and returning it in the attached postage-paid envelope. For your own protection, please do this right away.

Warranty

The Gravelly Tractor and attachments are warranted to be free from defective material and workmanship for a period of ninety (90) days from the date of purchase. All defective parts will be replaced without charge, provided such parts are returned to the Seller, transportation charges prepaid, and in the Seller's opinion, after inspection, are defective, and have not been damaged through neglect, accident or misuse.

IMPORTANT

This warranty is not valid or effective unless within seven (7) days after delivery of your equipment you complete the "Warranty Registration Card" and mail it to

GRAVELLY



GRAVELLY LANE
DUNBAR
WEST VIRGINIA 25064

The Gravely Tractor

The Gravely Tractor is powered by the air-cooled, four-cycle, one-cylinder Gravely Engine, which is rated conservatively at 6.6 HP at 2600 RPM. The Tractor Wheels are driven through an all-gear, automotive-type Transmission, while front-mounted power attachments are powered by a direct drive.

FUEL

Use a good regular gasoline, not highest. We recommend Mobil Regular (a Mobil product). Fuel Tank capacity is approximately two gallons, but to allow for expansion, do not fill over 1¾ gallons.

TIRES

Tire size is 4.00 x 8, 16-inch outside diameter. Inflate the Tires to maximum pressure of 18 pounds.

REPAIRING FLAT TIRE. Engage both Operating Levers (See Figure 2) to prevent the Tractor from moving. Be sure the Tube is deflated fully by removing its Valve Core.

Then loosen, but do not remove, the three hex-head cap screws in the Rim. Raise the Wheel off the ground, and remove it from the Tractor by removing the three hex-head cap screws.

With the Wheel removed, remove the three remaining bolts to separate the Rim and expose the Tube. Repair the Tube with any commercial patching kit.

INSTALLING NEW TIRE. Follow the above procedures, making sure the Tire being replaced is deflated fully before you remove its Wheel from the Tractor.

LUBRICATION

Filling the Chassis to its five-pint capacity with motor oil lubricates both the Engine and Transmission. Do not use transmission oil or grease. We recommend these oils:

Summer—Mobiloil A (SAE 30) or Mobiloil Special (SAE 10W-30).

Winter (32° F. or below)—Mobiloil Arctic (SAE 20W) or Mobiloil Special (SAE 10W-30).

OIL LEVEL. Routinely check the oil level with the Dipstick, 1 in Figure 1, before starting. Be sure the Tractor is level.¹

ADDING OIL. Add oil by removing the Oil Filler Cap, 2 in Figure 1. Stop when oil reaches the FULL mark on the Dipstick. **Note:** Allow enough time for the oil to seek its own level before checking to see if the FULL mark has been reached. This prevents over-filling the Chassis.

OIL FILLER CAP. Periodically check the "breather" type Oil Filler Cap. Wash it in a solvent when needed.

OIL CHANGES. During the break-in period, the first 40 hours of operation, change oil every 20 hours. Then change oil every 60 hours under normal conditions, or every 40 hours under very dusty or dirty conditions and during extended operation. Drain used oil by removing the Oil Drain Plug, the bottom bolt in the left Tractor Axle Housing², 3 in Figure 1. In replacing this Nylon-plugged bolt in the bottom bolt hole, be sure the special sealing washer is in place.

OIL FILTER. For best results, we recommend changing the Oil Filter every 80 hours, although satisfactory results may be obtained by changing it every 150 hours, maximum, or once a season, whichever is shorter.

The Oil Filter, 4 in Figure 1, is designed to be unscrewed by hand from its Bracket. However, to break the seal, it may be necessary sometimes to use slight force.

When attaching a new Filter, do not overtighten, as this may damage the seals.

Note: Do not change the connections in any way when replacing the Oil Filter.

OIL PRESSURE. A glance at the Oil Pressure Gauge when starting tells you whether oil pressure is correct.³ If oil pressure is not correct, stop the Engine immediately and call your Gravely dealer.

AIR CLEANER

Next to proper lubrication, care of the Air Cleaner is vital to Engine life—so vital, in fact, that the Gravely Warranty does not apply to parts worn or damaged because of improper Air Cleaner care.

The "Double-Guard" Air Cleaner⁴, 5 in Figure 1, makes it virtually impossible to damage the Engine with dirty air; when the Cleaner becomes clogged with dirt particles, this blocks the flow of air to the Engine, thereby stopping the Engine.

However, as the Cleaner becomes clogged, the resulting air loss decreases Engine power. Thus, to prevent this partially or completely-clogged condition, follow these cleaning instructions every eight hours under normal conditions and every four under extremely dusty or dirty conditions:

1. Remove the wing nut and flat washer, and lift the entire Cleaner from the Tractor.
2. Remove the Upper Shell and pleated Element.
3. Drain the oil from the Lower Shell and remove the Wick.
4. Wash both Shells in a solvent and wipe dry with a clean cloth.
5. Wash the Wick in a solvent and press dry.
6. Wash the Dacron-felt pleated Element in a solvent until it is free of dirt.

¹On older Tractors not Dipstick-equipped, check oil level by opening the bronze Try-cock Valve (or, on some models, the Oil Level Plug), located on the Chassis to the front of the right Axle Housing. If oil runs out, the oil level is proper; if not, add oil until it begins to run out.

²On Tractors with Serial Number M-15475 and below, the Oil Drain Plug is on the bottom of the Chassis.

³On Tractors without an Oil Pressure Gauge, check oil pressure by removing the Oil Filler Cap and observing, with the Engine running, whether the oil is moving in a smooth, steady stream. Be careful when removing the Cap, as the oil will splash upward. If the oil is not flowing, or flowing sluggishly, stop the Engine immediately and call your Gravely dealer.

⁴On Tractors with the Oil Bath Air Cleaner, painted black, inspect it daily during normal use and hourly under extremely dusty conditions. During extended industrial use, we recommend servicing the Cleaner every four hours, or more frequently if inspection shows this is needed. To service, empty the dirty oil and dirt particles from the Bowl, clean the Bowl with a solvent, and fill to the indicated level with the same oil as is being used in the Tractor.

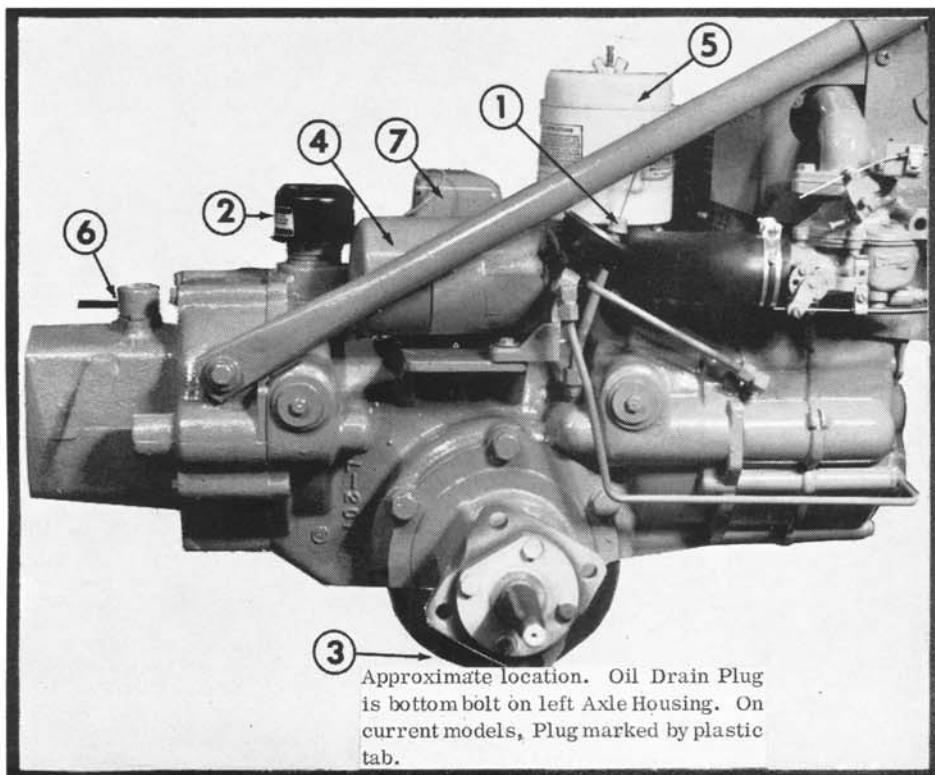

Figure 1

Be careful not to rap it against hard objects, brush it with a heavy brush, or otherwise handle it in such a way as to rupture it (even a minute puncture is large enough to allow dirt particles to by-pass the Element and enter the Engine). Shake the Element vigorously to remove excess solvent.

7. Saturate the Element with same oil as used in the Engine. Allow it to drain 15-20 minutes, and then wipe off excess oil with a soft cloth.

8. Place the Lower Shell back on the Tractor, being sure it fits snugly against the Mounting Bracket and gasket. Fill the Lower Shell with same oil as used in the Engine, until the Wick is barely covered.

9. Place the Element in the Lower Shell and cover with the Upper Shell. Be sure the rubber seals at the top and bottom of the Element are not damaged and fit snugly in place.

10. Place the flat washer on top of the Upper Shell's rubber grommet. Secure the wing nut. **Note:** The wing nut has a special Nylon insert which serves as an air seal. Be sure the wing nut you use has this Nylon insert.

TRACTOR CONTROLS

THROTTLE. The Throttle is mounted on the left Tractor Handle. Depress to feed fuel; raise to decrease fuel.

CHOKE. The Choke Control is on the left Tractor Handle, near the Throttle.⁶ Pull to choke; push forward fully for normal operation.

OPERATING LEVERS. The Operating Levers, one for high and low speeds and one for forward and reverse, are on the

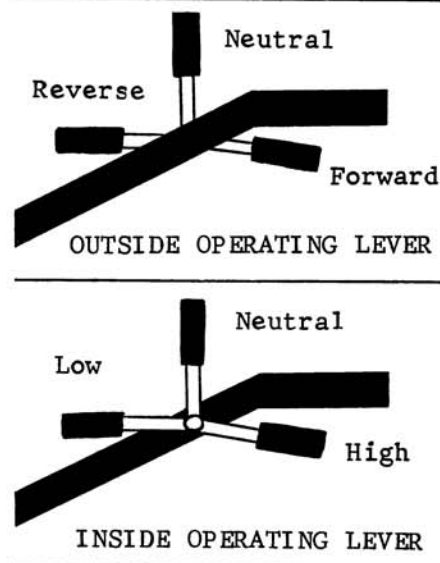

Figure 2

⁶On older Tractors, the Choke Lever is on the Carburetor. To choke, move the Lever vertical to the ground; for normal operation, have the Lever horizontal to the ground.

⁷An Ignition Stop Switch accessory is available for older Tractors. If you have an older Tractor not equipped with the Ignition Stop Switch, stop the Engine by depressing the Magneto Stop Button, mounted on the Magneto, 7 in Figure 1.

right Tractor Handle. See Figure 2 for Lever positions.

RANGE SELECTION LEVER. On Tractors with the optional eight-speed Transmission, the Range Selection Lever is mounted on the right by the Fuel Tank. Push forward fully for low range; pull rearward fully for high range.

ATTACHMENT CLUTCH LEVER. The Attachment Clutch Lever, 6 in Figure 1, puts the power attachment in and out of gear. Lever positions are shown by the embossed IN and OUT.

ATTACHMENT CLUTCH CONTROL. The Attachment Clutch Control, an accessory shown on Page 5, is an extension of the Attachment Clutch Lever that enables you to operate the power attachment from your position at the Tractor Handles. Pull to engage the attachment; push to disengage it.

IGNITION STOP BUTTON. To stop the Engine, simply depress the Ignition Stop Button, located in the rear of the right Tractor Handle.⁸

ATTACHING TOOLS

All Gravelly power attachments are attached to the front of the Tractor by four bolts. See instructions on Page 7.

Also, several non-power attachments are secured to the front of the Tractor in the same way. See instructions starting on Page 20.

Other non-power attachments are secured to the rear of the Tractor by the Gravelly Rear Hitch. See instructions on Page 23.

STARTING THE TRACTOR

Whether you have the Strap (manual) Starter or Electric Starter, before starting your Tractor check to insure that the:

- Operating Levers are in neutral;
- Attachment Clutch Lever (or Attachment Clutch Control) is at the OUT position;
- Valve on the Sediment Bowl (the glass bowl by the Carburetor) is open;
- Throttle is depressed approximately half-way;
- Ignition Stop Switch (if you have an older Tractor so equipped) is ON; and,
- An attachment or Attachment Boss Cover is secured to the front of the Tractor by four bolts.

NORMAL STARTING. On Tractors with the Strap Starter:

1. Turn the Pulley shown in Figure 3 counter-clockwise (opposite the direction of the arrow on the Pulley) as far as possible.
2. Attach the Strap to the Pulley (place the hole in the Strap over the pin in the Pulley groove) and wind the Strap onto the Pulley in the direction of the arrow.
3. Pull the Strap hard and fast. Choke as required.

With the Electric Starter, simply press the Starter Button with your foot. Choke as required.

Note: In proper working order, the Engine should start with one or two attempts (a few more may be necessary

in cold weather). If it doesn't, check the "Trouble Shooting" section on Page 3 to find and correct the trouble. Do not tamper with the Carburetor—this will only serve to complicate things, for even with the Carburetor out of adjustment, the Engine will start.

COLD WEATHER STARTING. Cold weather starting troubles usually can be avoided if you:

- Make sure the proper weight oil is used. Oils heavier than those recommended will stiffen at low temperature, thus making starting more difficult.
- Use fresh gasoline.
- Store the Tractor in a heated building, or if this is not possible, pre-heat the Engine by any safe method, such as the Gravelly Engine Heater accessory on Page 6.

CAUTION

Do not use a blowtorch or open flame. Check for oil and gasoline leaks before pre-heating the Engine.

To start the Engine in cold weather, choke fully and depress the Throttle half-way. Pull the Strap hard and fast—several attempts may be required. Return the Choke Control to the running position gradually as the Engine warms up.

If the Engine floods, move the Choke Control to the running position, depress the Throttle fully, and continue starting attempts.

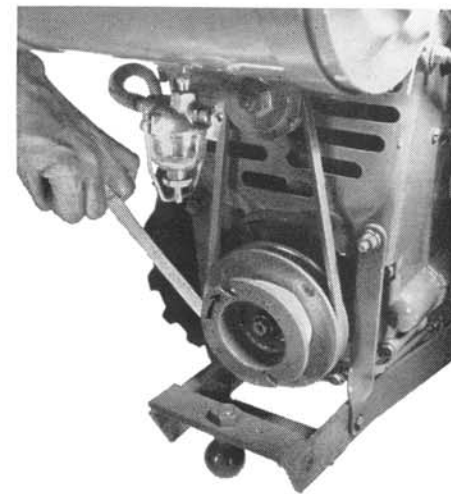

Figure 3

TRACTOR OPERATION

When starting the Engine have both operating Levers in neutral and the Attachment Clutch Lever at the OUT position (or the Attachment Clutch Control pushed forward fully).

If you have the optional eight-speed Transmission, the Range Selection Lever should be in the position for the range in which the Tractor will be operated initially.

After starting, decrease Engine speed to a fast idle.

ENGAGING WHEELS. To put the Tractor in motion, first move the Inside Operating Lever into high or low. Then move the Outside Operating Lever into forward or reverse. Use a smooth, even motion in shifting the operating levers. Depress the Throttle to the desired speed.

Note: With the Inside Operating Lever in high or low and the Outside Operating Lever in neutral, the Tractor will not move. Both Levers must be engaged before the Tractor will move.

ENGAGING POWER ATTACHMENT. Before attempting to put a power attachment in gear, be sure the Tractor is stopped, with both Operating Levers in neutral and the Engine running at idle speed.

To engage the attachment, move the Outside Operating Lever forward just enough to make the Engine "pull down" slightly. At the same time, move the Attachment Clutch Lever to the IN position (or pull the Attachment Clutch Control fully to the rear).

After the attachment is engaged, increase Engine speed to about half-throttle, and move the Inside Operating Lever to high or low. Put the Tractor in motion by moving the Outside Operating Lever to forward or reverse.

CAUTION

Never work on an attachment when it is running. Always stop the Engine—and be sure the attachment is disengaged and stopped completely—before attempting any adjustments or repairs.

- Keep hands and fingers away from the Fan and Fan Belt when the Engine is running. Always stop the Engine and be sure the Fan is not moving when working in this area.

- Beware of the Muffler, as it becomes very hot when the Engine is running. Allow it to cool, with the Engine stopped, before attempting to handle it.

DISENGAGING POWER ATTACHMENT. If you have the Attachment Clutch Control, the attachment may be disengaged while the Tractor is in motion simply by pushing the Clutch Control forward fully.

If the Tractor has only the Attachment Clutch Lever, stop the Tractor and cut the Engine off. Be sure the attachment is not moving before you attempt to move the Lever to the OUT position.

STANDARD TRANSMISSION. The Standard Transmission has four speeds—high and low in forward and high and low in reverse. These speeds control both ground speed and attachment RPM, with low gear having approximately 75 per cent of the speed obtainable in high gear.

The Inside Operating Lever may be shifted between high and low while the Tractor is moving (See caution, Page 12). The Outside Operating Lever should be shifted between forward and reverse only when the Tractor is stopped or moving at a very slow speed.

Choice between high and low gear will be governed mainly by actual operating conditions. Generally, difficult jobs such as snow blowing, plowing, cultivating, and heavy mowing should be done in

low gear, while easier jobs such as lawn mowing can be done in high gear.

EIGHT-SPEED TRANSMISSION. The eight-speed Transmission features a two-speed axle that can be shifted between high and low ranges. In each axle range the Operating Levers can be shifted between forward and reverse and between high and low. This gives the Tractor four speeds forward and four reverse.

Shifting the axle between high and low ranges controls only the Tractor's ground speed. Shifting the Inside Operating Lever between high and low provides a further control over ground speed, as well as attachment RPM. With the axle in low range, Tractor ground speed is 50 per cent slower than with the axle in high range.

To shift between axle ranges: Stop the Tractor (see caution below) and cut Engine speed to an idle. Keep the Inside Operating Lever in high or low, but move the Outside Operating Lever to neutral. Move the Range Selection Lever to high or low range. Move the Outside Operating Lever back and forth slightly, and then engage it in forward or reverse.

CAUTION

Never shift the Range Selection Lever while the Tractor is moving. Always come to a complete stop before shifting.

- Never shift the Range Selection Lever when stopped on a hill. If you must shift while working on an incline, before shifting, stop the Tractor so it points across the slope rather than down it.

Individual jobs will dictate the combination of axle range and gear to be used. In general, low axle range should be used for plowing, cultivating, snow blowing, heavy mowing, and other jobs where a slower ground speed is needed to give the attachment longer to do its job. High axle range generally is satisfactory for mowing and other lawn jobs.

BRAKING. The Outside Operating Lever may be used as a "brake" when you must stop suddenly or wish to stop momentarily while going down an incline. Quickly move the Lever out of forward, pass through neutral, and apply pressure at the reverse position—enough pressure to stop the forward motion of the Tractor, but not enough pressure to lock the Lever fully in reverse.

OPERATING IN REVERSE. When operating the Tractor in reverse, we recommend that you keep your hand on the Outside Operating Lever. Thus, should you fall or get pinned against a wall or fence, you can stop the Tractor immediately by moving the Lever to neutral. See "Safety Reverse" on Page 4.

OTHER POINTS. Don't slip the Clutch. If you find the ground speed of the Tractor too fast for the job, don't ease the Outside Operating Lever in and out of gear to maintain the required ground speed. Instead, shift to a lower gear (on the Standard Transmission to low gear; on the eight-speed Transmission, to low axle range). Or if you can't shift any lower, take a smaller bite—one in which the attachment can do the job with the Tractor fully in gear. Repeated Clutch clipping causes undue wear and thus should be avoided.

- Keep the bolts and nuts tight. Have a regular time to go over the Tractor and tighten them.

- Don't try to help the Gravelly. Remember, it's much stronger than you are. But powerful as it is, it still takes orders from you. Just give your Gravelly the "guidance" it needs—and leave the hard work to it.

STOPPING THE ENGINE

Take the attachment out of gear, move the Operating Levers to neutral, and cut Engine speed to an idle. Then depress the Ignition Stop Button (on the end of the right Tractor Handle). On older Tractors with the Ignition Stop Switch, pull to stop; if not Switch-equipped, depress the Magneto Stop Button.

TROUBLE-SHOOTING

The Gravelly Engine, like any internal combustion engine, occasionally may fail to start. Following are the more common malfunctions and the necessary corrective measures.

FUEL TROUBLES. Check to see if the:

- Fuel Tank contains fresh fuel.
- Fuel Tank Cap venting system is clear.

- Fuel Cut-off Valve (on the Sediment Bowl) is open. Turn counter-clockwise to open.

- Fuel line is clear. Close the Cut-off Valve, remove the Sediment Bowl, and reopen the Valve. If fuel flows, the line is clear; if not, check the Neoprene Fuel Hose and fittings.

- Carburetor is getting fuel. With the Sediment Bowl and fuel line intact, close the Cut-off Valve. Drain any fuel remaining in the Carburetor by removing the plug from the bottom of the Carburetor. Open the Cut-off Valve. If fuel does not flow out the bottom of the Carburetor, there is an obstruction in the Carburetor. Call your Gravelly dealer.

IGNITION TROUBLES. Check to see if the:

- Spark Plug is shorted out by contacting a bent or damaged Tractor Hood, especially if the rubber Spark Plug Cap is split, worn through, or missing. Raise the Hood and attempt to start the Engine.

- Spark Plug is fouled or wet. Remove the Plug and clean or dry it. Reset the gap to .033-inch.

- Proper Spark Plug is used. The Autolite TT-10 is recommended.

- Engine is getting a spark from the Magneto. Remove the Magneto Cable from the Spark Plug and crank the Engine by hand, holding the Cable end so the spark can jump to the Cylinder Head. If there is no spark when the Magneto is heard to click, or a weak spark (less than 3/16-inch) check the connections. If these are all right, the Magneto is defective. Call your Gravelly dealer for service.

- Ignition Stop Switch (on older Tractors) is ON.

- Ignition Stop Button (or Ignition Stop Switch, on older Tractors) is shorted out. To test, remove the cable from the Magneto Stop Button and attempt to start the Engine.

CARBURETOR AND AIR CLEANER TROUBLES. A flooded Carburetor or clogged Air Cleaner may keep the Engine from starting. To check, first disconnect the Air Cleaner Hose and hold it pointing downward.

If fuel drains from the Hose, the problem is Carburetor flooding (another indication is that the Carburetor will be wet). To correct, allow the Hose to drain completely, reconnect it to the Carburetor, and start the Engine.

Note: Carburetor flooding is more likely to occur on older Tractors having a long, curved Air Cleaner Hose. Current models with a shorter, straighter Hose seldom have this difficulty.

If fuel does not drain from the Hose, the problem most likely is a clogged Air Cleaner. To check, examine the Element. If needed, clean the Air Cleaner and reconnect the Hose to the Carburetor.

CAUTION

Never start or run the Engine with the Air Cleaner Hose disconnected; this introduces dirt and grit into the Engine, scoring the Cylinder quickly and making necessary a major repair job.

OTHER TROUBLES: CALL YOUR DEALER. The above procedures in almost all cases will get your tractor started. However, if these fail, call your Gravelly dealer, who is trained in factory-approved service procedures and who has the parts, if required, to get your Gravelly working for you once more.

ADJUSTMENTS YOU SHOULD KNOW

Following are common adjustments which most users can perform readily.

SPARK PLUG. The Autolite TT-10 Spark Plug, which gives a medium spark, should have its gap set to .033-inch.

CLUTCH RODS. The need for Clutch Rod adjustment is indicated by slippage when the Operating Levers are locked in position. To adjust, tighten the lock nuts, 1 and 2 in Figure 4, until the Clutch Rod Springs are compressed fully as each Lever is locked into position. The Tractor may "creep" a little on occasion, even in neutral, but this does not indicate the need for Clutch adjustment.

SAFETY REVERSE. The Outside Operating Lever can be adjusted so that it must be held in reverse, instead of being locked in this position. When adjusted this way, the Tractor automatically goes into neutral when pressure is released from the Lever. To perform this adjustment, run the lock nuts on the lower end of the Outside Clutch Rod up to a point where the Lever cannot be locked into reverse; when adjusted properly, the Lever returns to neutral when pressure is released.

EIGHT-SPEED TRANSMISSION LINKAGE. The Toggle Spring (located by the Range Selection Lever) occasionally may require adjustment by tightening the hex nuts on the Toggle Rod until the Spring is compressed to 15/16-inch.

The Clutch Springs, 3 and 4 in Figure 4, occasionally may need to be adjusted. With the Range Selection Lever engaged fully in high or low range, move the hex nuts on the Spring Rod until each Spring is compressed to 2½ inches.

CARBURETOR. If absolutely necessary to adjust the Carburetor, follow these instructions:

1. Screw the Jet Adjustment Valve (a brass T-valve) in until it is snug. Do not force or screw it tightly.

2. Back the Jet Adjustment Valve off 2¾ turns.⁷

3. Start the Engine and depress the Throttle half-way. After the Engine warms up, begin screwing the Jet Adjustment Valve in slowly. As soon as

the Engine slows down, stop and back the Valve off ½ turn.

4. Screw the Idle Air Jet Adjustment Valve (a slotted-head screw with a spring wound around it) all the way in; then back it off 1½ turns.⁸ Start the Engine and allow it to idle. Screw the Idle Air Jet Adjustment Valve in until the Engine begins to buck, spit, or backfire. Then back the Valve off ½ turn. If the Engine still runs roughly, back it off another ¼ turn.

Special instructions for Gravelly Carburetors are available from the factory. Please give the make and model of your Carburetor when writing for instructions.

VALVES. Adjust the Valves only when the Engine is cold. Remove the Valve Cover Cap, shown in Figure 5, and use a 7/16-inch open-end wrench to adjust Tappet clearance to .012-inch. This is a self-locking Tappet.⁹

FAN BELT. Fan Belt tension is adjusted by moving the Fan Belt Pulley (the smaller Pulley at the rear of the Tractor) up, to increase tension, or down, to decrease tension. The Fan Belt is in proper adjustment when moderate pressure applied at its mid-point will deflect it approximately ¾ inch.

Note: Under no circumstance should you attempt to adjust the Fan Belt while the Engine is running.

To adjust, loosen the large thin nut between the Fan Belt Pulley and Fan Housing. If you do not have a wrench thin enough for this, loosen the bolt that holds the Fan Pulley to the Fan Pulley Shaft. Slip the Pulley away from the Fan far enough to get a thicker wrench onto the large thin nut.

After the nut is loosened, move the Fan Belt Pulley up or down as required. Tighten after proper tension is reached.

TIMING. The Magneto should be set to fire 30° ahead of top dead-center on the compression stroke (which is when both Valves are seated). To adjust:

1. Loosen the Magneto Coupling Bolt, 1 in Figure 6, until the Coupling, 2 in Figure 6, moves on the Magneto Shaft Extension, 3 in Figure 6. It may be necessary to tap the Coupling gently.

2. Turn the Engine by hand to the beginning of the compression stroke. Remove the Spark Plug to observe (or for greater accuracy, to measure) when the Piston is at top dead-center.

3. Take up gear backlash. Then hold the Magneto Shaft Extension with vise-grip pliers to keep it in proper relation to the Piston at top dead-center. Rotate the Magneto Impulse (inoperative) until the timing marks, a line on the Coupling flange and a dot on the Magneto face, are in coincidence.

4. Reassemble the Magneto Coupling, inserting a .015-inch (or 1/64-inch) feeler gauge between the fiber block and Coupling flange before tightening. Be sure the timing marks remain in coincidence while tightening the bolt.

⁷On the cast iron Carburetor (Part Numbers 9995 or 9995-A), back the Jet Adjustment Valve off 2½ turns.

⁸On the cast iron Carburetor, back the Idle Air Adjustment Valve off one full turn.

⁹On Tractors with Manufacturing Number B-7619 and below, turn the Engine over by hand to the end of the compression stroke (both Valves seated and the Piston at top dead-center). Raise the Spring Sleeves. Adjust so there is .012" clearance between the Valve Stem and Valve Plunger; this is done by holding the 9/16" Valve Adjusting Nut in place and tightening or loosening the ½" nut. When proper clearance is reached, lock in place with the 9/16" nut.

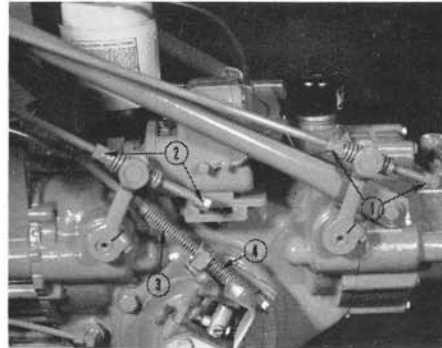

Figure 4

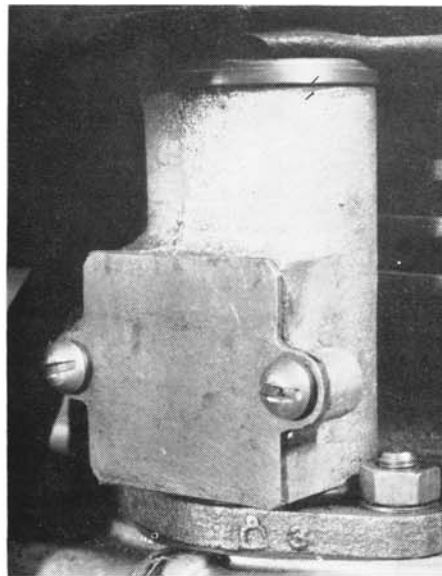

Figure 5

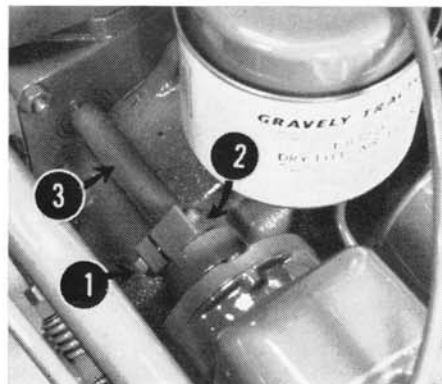

Figure 6

STORING THE TRACTOR

Although the Gravely has attachments for year-round use, perhaps you do not plan to use it during the winter. If so, it is important that you store your Tractor according to the following directions:

STORAGE. Clean the Tractor thoroughly with kerosene and a stiff brush. This, and following storage procedures, should be done in a well ventilated room and away from open flame. Then:

1. Drain the Fuel Tank (by removing the Sediment Bowl, next to the Carburetor).

2. Drain the Chassis (see "Oil Changes"), flush with kerosene, and refill with Mobiloil A (SAE 30) or Mobiloil Special (SAE 10W-30). Run the Engine two minutes to distribute the oil, but do not get the Engine hot.

3. Remove the Spark Plug and put ¼ pint of the same oil as used in the Tractor in the Cylinder. Turn the Engine over by hand (by turning the Fan Belt Pulley at the rear of the Tractor) several times. Leave the Piston on top dead-center and replace the spark plug.

4. Store in a dry place, with the Wheels jacked up off the floor. If the Tractor must be stored outside, we rec-

ommend use of the Tractor Cover, described on Page 6.

REMOVING FROM STORAGE. Turn the Engine over by hand several times. If the Engine stops suddenly, or turns too easily, the Valves may be sticking. (See "Valve Adjustment.") Then:

1. Fill the Fuel Tank with fresh gasoline.
2. Inflate the Tires to 20 pounds pressure.
3. Change the Oil Filter, if required.
4. Start the Tractor in the usual way.

Do not be alarmed if there is heavy exhaust when first started; this is merely excess oil being burned off.

Gravely Accessories

DUAL WHEELS

Dual Wheels are useful in situations requiring extra traction, as in use of the 48-inch Snowplow for bulldozing, hauling heavy loads in the Transportation Cart, and mowing terraces and slopes with Gravely mowing attachments. Dual Wheels allow you to mow slopes as steep as 60 per cent. Dual Wheels always should be used when the Steering Sulky is used.

To attach:

1. Remove the three hex-head cap screws that hold the Wheel Rim to the Tractor.

2. Attach the Spacer to the inside Wheel Rim and Tractor by inserting the three long cap screws provided through the holes in the Spacer. Tighten these screws firmly. Be sure the Spacer recess with the small indentation fits over the inside Wheel's Tire Valve.

3. Use the three short cap screws which were removed initially to attach the outside Wheel Rim to the Spacer.

No lubrication is required.

ATTACHMENT CLUTCH CONTROL

The Attachment Clutch Control, mounted on the left Tractor Handle, enables you to engage and disengage power attachments without leaving your position behind the Tractor. Your Gravely dealer can install it quickly.

Pull the Attachment Clutch Control to engage a power attachment; push it to disengage.

ELECTRIC STARTER

A touch of your toe and away you go—that's what happens when you have the Gravely Electric Starter.

The Starter, which uses a standard automobile or tractor battery (12 volts), gives you year-round ease and conveni-

The following accessories are standard equipment on current-production Tractors:

Accessory	Gravely Custom	Gravely Super
Dipstick	•	•
Oil Pressure Gauge	•	•
Ignition Stop Button	•	•
Rear Hitch	•	•
Attachment Clutch Control	•	•
Electric Starter	•	•
Governor	•	•

ence in starting. It is especially useful in cold weather starting.

Installation instructions are packed with the Starter. If you prefer, your Gravely dealer can install it for you quickly and at low cost.

GOVERNOR

The Gravely Governor makes operation of the Tractor easier because it feeds the proper amount of fuel to the Engine at

all times automatically. In addition to this convenience, it prolongs Engine life by preventing racing of the Engine and by matching fuel flow to Engine load.

It is especially useful in plowing and mowing—operations in which the load on the Engine varies greatly.

Installation and lubrication instructions are packed with the Governor. However, we recommend that you have your Gravely dealer install the Governor, because he has the tachometer which is required to adjust it properly.

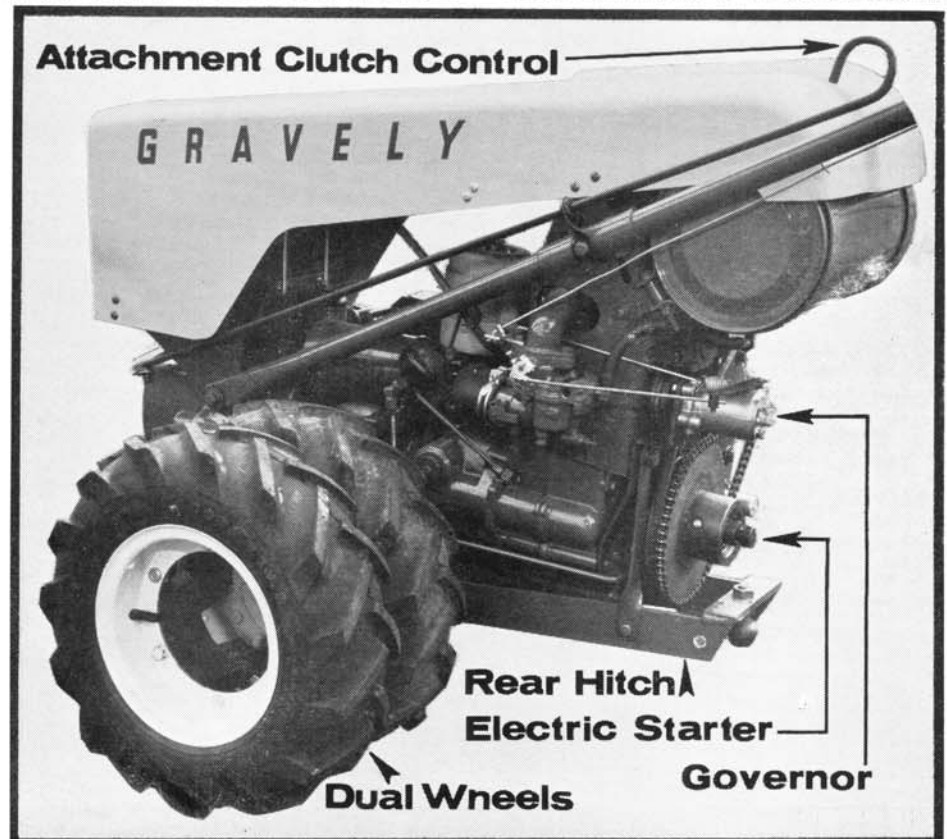

GEAR REDUCTION WHEELS

Gear Reduction Wheels reduce the ground speed of the Tractor approximately 50 per cent without decreasing the speed of the attachment.

Gear Reduction Wheels are almost indispensable when using the Rotary Plow on very hard ground, sod land, or

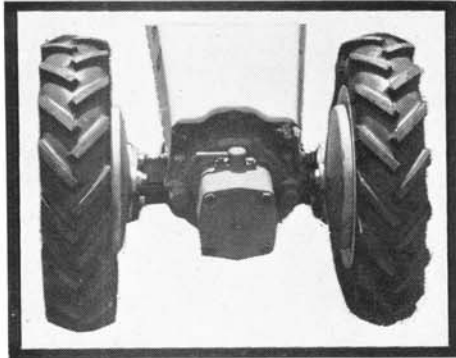

Gear Reduction Wheels

gumbo, and are also useful under certain conditions with the Snowblower, Chain Saw, and Circular Saw.

To attach:

1. Remove the Wheel, following procedures outlined under "Extension Axles." Do not remove the Bearing Cap and Axle.

2. Put the Pinion Gear onto the Tractor Axle, with the Axle Key in place.

3. Pack the inside of the Gear Reduction Wheel with from one to 1½ pounds of Mobilgrease MP. No additional lubrication is required.

4. Slip the Gear Reduction Wheel over the Pinion Gear, matching the four holes in the Tractor Axle Housing with those in the Wheel; the Wheel will go on only with its short stub fitting into one of the half-moon cut-outs on the rim of the Tractor Axle Housing.

5. Insert the four bolts and tighten securely.

Gear Reduction Wheels should carry from 20 to 25 pounds of air.

Height adjustment is made by removing the Tractor Axle Housing, rotating the Housing, and replacing.

Note: On Tractors with Serial Number M-15476 and above, the bottom bolt on the left Tractor Axle Housing (left as you stand at the Handles) is the Oil Drain Plug. In replacing, be sure this Nylon-plugged bolt is in the bottom hole, and that the special sealing washer is in place.

DIPSTICK

The Oil Level Dipstick enables you to check quickly the oil level in your Tractor. Your Gravelly dealer can install it for you quickly.

EXTENSION AXLES

Extension Axles, by making the distance between Wheels greater, give the Tractor greater stability. In turn, this makes handling the Tractor on steep slopes easier and more efficient.

On jobs where very steep slopes are to be mowed (levees and railway embankments, for example) both the Ex-

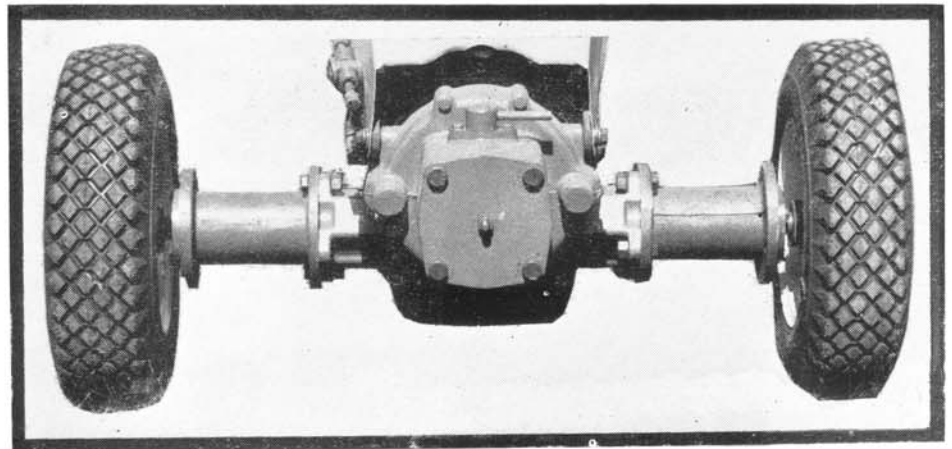

Extension Axles

tension Axles and Dual Wheels may be used with a special-length Cutter Bar on the Sickle Mower. Equipped this way the Tractor can mow anywhere a man can walk.

Note: Extension Axles cannot be used with Tractors having the optional eight-speed Transmission.

To attach:

1. Remove the Hub Cap from the Wheel and remove the large elastic stop nut which holds the Wheel to the Tractor Axle.

2. Place blocks under the Tractor so that the Wheels are off the ground.

3. If you have a wheel knocker, screw it onto the Tractor Axle and tap with a hammer until the Wheel breaks loose. Then remove the Wheel.

If you do not have a wheel knocker, insert a tapered punch or wedge between the Tractor Axle Housing and Wheel Hub and drive it down gradually, wedging the Wheel loose.

4. Remove the four cap screws from the Bearing Cap and remove the Cap and oil seal. Remove the Tractor Axle and Bearing.

5. Insert the splined end of the Extension Axle into the Tractor Axle Housing, lining up the splines with the gears inside the Tractor by twisting the Extension Axle gradually.

6. Secure the Extension Axle Housing to the Tractor Axle Housing by the four bolts provided. Be sure the nuts are tightened firmly.

7. Replace the Wheel, elastic stop nut, and Hub Cap.

No lubrication is required.

MUFFLE-TONE SILENCER

The Gravelly Muffle-Tone Silencer lessens the high-pitched noises caused by Engine exhaust. It is useful when working around hospitals, schools, and other areas where sharp noises are not desired.

The Silencer, made of heavy-gauge steel, is easily attached to the Exhaust Manifold.

TRACTOR COVER

The Gravelly Tractor Cover protects your Tractor from weather, fire, and water damage, as well as from tampering. It

is built to last—made of fire-proof, mildew-proof, and water-proof heavy duck. It has reinforced grommets, edges, and cutouts.

The Cover fits snugly over the Handles and reaches to the ground or floor.

It is recommended for outside storage of the Tractor.

OIL PRESSURE GAUGE

The Oil Pressure Gauge can be installed quickly by your Gravelly dealer. It lets you determine at a glance if your Tractor has the proper oil pressure. Instead of removing the Oil Filler Cap to check the oil flow, you check it with just a glance when you have the Oil Pressure Gauge.

ENGINE HEATER

Cold weather starting is even easier when you pre-heat your Gravelly with the Gravelly Engine Heater. Just plug it in for easy starts. This economical accessory may be left attached permanently to the Tractor.

TIRE CHAINS

Tire Chains are useful when using your Tractor for snow removal, especially when there is a thin glaze of ice under the snow. Tire Chains are easily put on and taken off, and provide the extra traction required.



Tire Chains

Gravely Power Attachments

ATTACHING TO TRACTOR

The Drive Assembly of each power attachment is attached to the front of the Tractor by four bolts. When attaching, tighten securely one of the top bolts before tightening the other three. When detaching, remove completely both bottom bolts and one of the top bolts before removing the other top bolt.

When attaching, be sure the Engine is stopped and the Attachment Clutch Lever (or Attachment Clutch Control) is at the OUT position. The Tractor and attachment should be on level ground. To keep the Tractor from moving, the Operating Levers may be engaged, but both must be returned to neutral when the Tractor is started.

SAFETY CLUTCH

Each attachment has a Safety Clutch which stalls the attachment when an obstacle is hit, preventing damage to both the Tractor and attachment.

The Clutch is properly adjusted when there is a .025-inch gap between coils of the springs around the six bolts of the Clutch. Check the gap periodically with a feeler gauge.

To decrease the gap, tighten the bolts; to increase the gap, loosen the bolts. If excessive slippage is encountered after adjusting to .025-inch, decrease the gap to .020-inch.



Safety Clutch

CAUTION

Any time you adjust or do any work around an attachment, make sure the Tractor Engine is stopped and the attachment is disengaged and stopped.

20-GALLON SPRAYER

The 20-gallon Sprayer can be used for all types of spray material, including white-wash. Depending on the type of Disc used in the Spray Gun, the Sprayer has a maximum horizontal throw of 48 feet, and a maximum vertical throw of 34 feet.



LUBRICATION

No lubrication is required.

ATTACHING

The Sprayer is attached to the front of the Tractor by four bolts, as are all other power attachments. In attaching, loosen the Adjusting Handles on the Sprayer Tank Stands until the Stands are the approximate height necessary to attach the Tractor. After attaching, raise the Stands fully and lock the Adjusting Handles.

CHANGING NOZZLES

The Spray Gun is delivered with one Nozzle already inserted. To change Nozzles, simply unscrew the Nozzle Cap, remove the Disc, and replace with the desired Disc (orifice) or T-Jet. **Note:** When using the T-Jet, the Gun must be attached to the Tank by means of the Tank Gun Clamp, and the two openings in the T-Jet must be parallel to the ground.

OPERATING INSTRUCTIONS

See the table on Page 8 for data about application rates of the various Discs, and patterns to be expected using these Discs, at various settings. It is important that the proper Nozzles and Gun setting be used to suit the job, and that proper pressures are used. We recommend you study these data before beginning to spray.

LOADING THE TANK. Remove the Lid and fill the Tank with the desired solution. Before loading check the Strainer for cleanliness.

Do not become concerned over a small amount of spillage from the vent in the Lid—the vent must be open for efficient operation. Any spill you obtain will be negligible.

OPERATING THE SPRAYER. Loosen the lock nut, 1 in Figure 7, and turn it clockwise until resistance is met. Then back it off 10 full turns. Close the Gun by turning the handle completely clockwise until resistance is met.

Start the Tractor Engine with the Sprayer out of gear. Set the Throttle at one-half, maximum.

Put the Sprayer in gear by engaging the Inside Operating Lever.

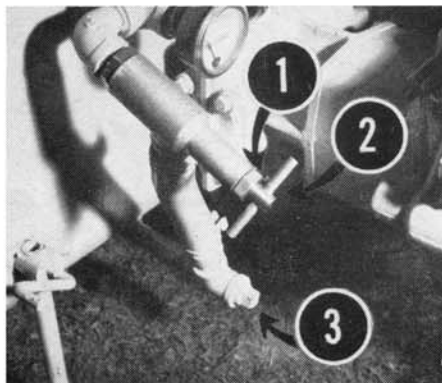

Figure 7

SETTING PRESSURE. See the table on Page 8 to determine proper pressure for the job you plan to do. Set the pressure by turning the Pressure Relief T-Valve, 2 in Figure 7, until the Pressure Gauge registers the desired pressure. This usually requires turning the T-Valve clockwise, which increases pressure.

USING THE SPRAY GUN. The large Handle on the Gun controls the shape of the spray pattern, either a cone-shaped or a jet-shaped spray. Adjust to suit your job requirement. See Figure 8 for parts of the Gun: 1 Gun; 2 Rubber Washer; 3 Disc; 4 Nozzle Cap.

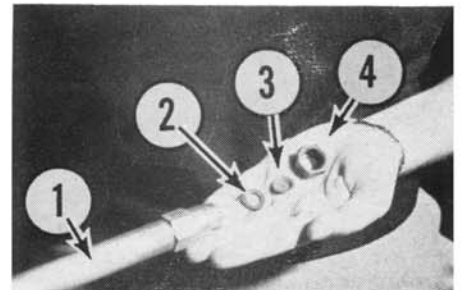

Figure 8

As mentioned previously, the Nozzles control the application rate in combination with the pressure. The Nozzles also control the "throw" of the Spray, with the larger Discs giving greater distance and a more concentrated pattern. For example, if you wish to spray a tall fruit tree, use the Disc with the largest opening, pressure as recommended, and the Gun adjusted to the jet-type spray. **Note:** Increase of Engine speed past one-half Throttle serves no useful purpose. The efficiency of the Pump is such that half-Throttle or less will provide adequate pressure.

POST-SPRAYING PROCEDURES

Drain all material from the Tank by removing the Drain Plug, 3 in Figure 7. Spray materials can be drained into a suitable container for storage.

After draining, replace the Drain Plug, and fill the Tank with five to 10 gallons of clean water. Start the Sprayer and

begin spraying. Using the Gun, you can clean the outside of the Sprayer and by inserting it inside the Tank, you can wash the Tank interior thoroughly.

Continue flushing, refilling if necessary, until the Tank and Gun are clean. Then remove the Drain Plug again, drain, and replace.

Clean the Strainer at this time, by removing the wing nut, 1 in Figure 9. Then hold the Strainer, 2 in Figure 9, under a faucet and flush it with clean water from the inside out.

DRAIN PUMP IF IN DANGER OF FREEZING

In cold weather—when a freeze is anticipated—always drain the Tank, connections, and Pump.

To drain the Pump, remove the Drain Plug from the T-Joint, remove the clamp from the Pump end of the Pump-to-Tank Hose, and Hold down to drain. (Some Sprayers have the Hose replaced by a pipe and fittings. For these, remove the Drain Plug from the T-Joint at the same location.) Loosen the lock nut from the Pressure Relief Valve and turn the Valve counter-clockwise 5-10 turns.

Next, loosen, but do not remove, the

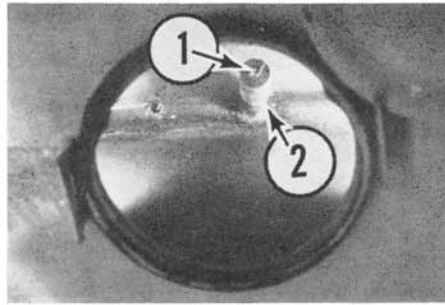

Figure 9

CAUTION

Spraying compounds usually are poisonous. Take the manufacturer's recommended safety procedures at all times, both in handling and spraying and in protection of by-standers, particularly children and animals. Do not allow children to operate the Sprayer, and keep it and all spraying materials out of their access.

Pump Caps. Loosen the bolts only until the Cap will come out about 1/8-inch. Both Caps should be treated this way. After draining is completed, replace the Caps and all connections and plugs.

HINTS FOR EASIER OPERATION

Be sure the apertures in the Discs and T-Jet are kept clean. Also, be sure the Strainer is kept clean. If these become clogged, the Sprayer will not produce a spray from the Gun.

- After using a corrosive or abrasive spraying compound, make sure the entire Sprayer is cleaned thoroughly, both inside and out. Doing this will add to the life and satisfactory performance of the Sprayer.

- If a leak in the plumbing develops, try to tighten slightly. If this doesn't work, replace the offending parts. Do not overtighten the connections—use minimum pressure to set these securely.

Any other malfunction of the Sprayer should be called to the attention of your Gravely dealer, who has the parts, tools, and knowledge to service it quickly and efficiently.

CONDENSED SPRAY GUN DATA

(All ratings taken at maximum pressure, 400 psi)

Disc	Maximum Stream Throw		GPM	Maximum		Angle of Spray	GPM
	Horizontal	Vertical		Horizontal Throw	Vertical		
D-2	35'	24'	.94	10.5'	17	.90	
D-4	39'	30'	1.90	11.0'	20	1.80	
D-6	48'	34'	4.10	11.0'	33	3.80	

T-JET: Gives fan spread of approximately 8-10', yields .47-1.64 GPM depending on pressure (which can be set from 25 psi to recommended maximum of 300 psi).

DELIVERY IN GALLON PER MINUTE

(Pressures in pounds per square inch, psi)

Pump RPM	Pressure (psi)							
	0	100	150	200	250	300	350	
900	6.9	5.2	4.2	4.1	4.0	3.8	3.6	
1000	7.2	5.6	4.8	4.8	4.8	4.3	4.1	
1100	7.6	6.5	5.5	5.5	5.5	5.3	5.3	
1200	8.1	7.1	6.3	6.3	6.3	6.2	6.2	
1300	8.7	7.8	7.1	7.1	7.1	6.7	6.6	

POWER TAKE-OFF

The Gravely Power Take-off can be used to run any equipment which gets its power from a belt and does not require more than 4.8 horsepower.

LUBRICATION

No lubrication is required.

ATTACHING

The Power Take-off is attached to the Tractor by four bolts, as are all other power attachments. The optional Stand, shown in Figure 10, may be bolted on at the same time the Power Take-off is attached. **Note:** When using the Stand, we recommend use of bolts 1/4-inch longer than the regular attachment bolts. These are available from your Gravely dealer.

COMPUTING PULLEY SIZE AND RPM

The table at right (based on the Power Take-off operating at 1200 RPM in high gear with Engine speed of 2400 RPM—Throttle depressed 2/3) shows RPM gen-

erated for various combinations of Power Take-off Pulleys and driven pulleys. Use this in determining Pulley requirements.

OPERATING HINTS

If you have a job requiring use of the Power Take-off frequently, you may find it desirable to bolt the Power Take-off Stand in position for the job. Then you can simply run the Tractor into position and attach the Power Take-off.

During operation, never run the Engine wide open on any job for an extended period of time.

Always be sure the belts running from the Power Take-off are properly aligned. Proper belt tension is a matter of experience for the individual task to be performed. The same applies to the size pulley needed.

Figure 10



PTO Pulley Diameter	Driven Pulley Diameter								
	4"	5"	6"	7"	8"	9"	10"	11"	12"
4"	1200	960	800	685	600	533	480	436	400
6"	1800	1440	1200	1028	900	800	720	654	600
12"	3600	2880	2400	2057	1800	1600	1440	1309	1200

SICKLE MOWER

The Sickle Mower is a rugged, dependable mower that makes the toughest weed and brush cutting easy. Swivel action allows the Blade to follow the ground contour to insure a clean cut.

Blades longer than the standard 42 inches are available from your Gravely dealer. Blades are provided with three-inch sections for heavy mowing and two-inch sections for finer mowing.

Using the Dual Wheels or Extension Axles, the Sickle Mower can cut slopes as steep as 60 per cent. See Pages 5 and 6.

LUBRICATION

Check the Drive Assembly oil level every four hours of operation by removing the Oil Level Plug, 1 in Figure 11. If oil runs out, the oil level is all right; if not, oil must be added.

To add oil, remove the Oil Filler Plug, 2 in Figure 11 and pour oil through the Oil Filler Hole until oil begins to run out the Oil Level Hole. Replace both Plugs before mowing.

Use Mobilube EP-140 (SAE 140) in the Drive Assembly.

To lubricate the Universal Joint, remove the Grease Plug, 3 in Figure 11, and fill about half-full with Mobilgrease MP.

Because the Universal Joint needs lubrication only occasionally, you may prefer this method: with the Mower detached from the Tractor, remove the Safety Clutch and four bolts, 4 in Figure 11, which hold the lower column to the Universal Housing and slip the Housing partly off. Then apply Mobilgrease MP generously to the Universal Joint (coat it all over with one to 1½ inches of Mobilgrease MP). Reassemble all parts, making sure you tighten firmly the large nut which holds the Safety Clutch.

ADJUSTMENTS

To insure satisfactory performance, perform the following adjustments as required:

BOLTS. Although the Sickle Mower is built and balanced carefully, it is still subject to some vibration. Periodically tighten all nuts and bolts, doing this at more frequent intervals when doing heavy cutting. **Note:** The Gravely Triple-Purpose Wrench, available from your Gravely dealer is required for the Actuating Lever Nut.

CLIPS. The Clips which hold the Knife to the Guide Bar should be adjusted frequently to prevent cut matter from "bunching" and causing improper feed-off. When in proper adjustment, the Clips should allow the Knife to slide back and forth easily (with the pressure of a finger and thumb). The Clips should hold the Knife in firm contact with the Shear Plates, but should not cause binding. To adjust, knock the Clips down gradually with gentle taps from a light hammer.

SWIVEL ACTION. To increase swivel action (allowing the Mower to follow the contour of the ground), loosen the bolts, 6 in Figure 11. When these bolts are tightened firmly, the Mower is held in a rigid position. The bolts should be tight enough so the Guide Bar will hold its position until lowered, but loose enough for the Guide Bar to follow the contour of the ground.

GUARDS. Always keep the Guards, 7 in Figure 11, in alignment by tapping these with a light hammer until the Knife Sections lie flat on the Shear Plates of the Guards. Keep the Guard Bolts tightened securely.

CARE OF THE KNIFE

For best performance, keep the Knife Sections sharp. To remove the Knife for sharpening, remove the Knife Bracket Screws, 5 in Figure 11, and slip the Knife out either side. Grind the Knife

Sections along the same bevel as ground originally. When replacing the Knife, make sure the Knife Bracket Screws are tightened firmly.

Note: It is good practice always to have an extra Knife, already sharpened, which you can put on the Mower when needed. This way you can always have a sharpened Knife in reserve. The Gravely Sickle Grinder (see Page 10) can be purchased from your Gravely dealer, or he will sharpen your Knife for a small charge.

No lubrication is required for the Knife while in operation, as juices from weeds and grass will furnish sufficient lubrication. However, to prevent rust, wipe the Knife and Guide Bar with a thin coat of light oil after operating. When the Mower is to be stored for any period of time, clean it thoroughly and apply Mobilgrease MP to all unpainted parts.

OPERATING HINTS

Always mow at a normal walking speed with the Tractor in low gear. Excessive speed will exaggerate the Mower vibration, causing nuts and bolts to become loose much faster than normal.

- If excessive vibration is encountered, check to see if the Wearing Tip (on the end of the Actuating Lever) is worn or missing, or if the Bracket is worn badly; if so, your Gravely dealer can replace these parts for you.

- If cut grass or weeds begin collecting on the Mower instead of feeding-off properly, check the alignment of the Guards and Knife Sections, as well as sharpness of the Knife Sections.

- If this does not correct the improper feed-off, make sure one end of the Mower is not dragging up already-cut material. This is the result of taking too small a "bite."

- Another cause of improper feed-off is a rusty or gummy Mower. Always keep it clean.

- Finally, the improper feed-off may be caused by improper adjustment of the Safety Clutch. See page 7.

CAUTION

Never attempt to clear the Mower, or make any adjustment whatsoever, unless the attachment is out of gear and stopped, and the Tractor Engine is stopped.

- Never handle the attachment by any cutting surface. Keep hands away from Knife Sections. Grasp the Mower by its Drive Column and other non-cutting surfaces to carry it.

- Try to keep clear of rocks and debris, as these will damage the cutting surfaces.

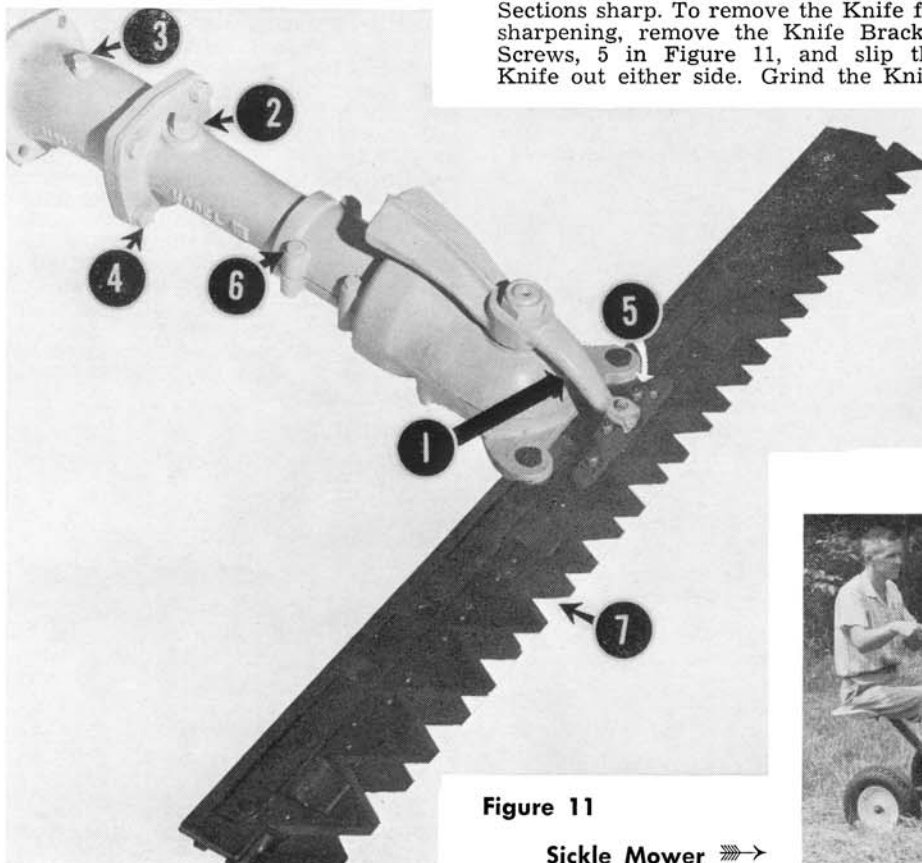

Figure 11

Sickle Mower ➡



SICKLE MOWER (continued)

SKIDS

Skids which fit under the Guide Bar are available from your Gravely dealer. For most mowing, these Skids are not necessary; however, you may want these for certain jobs, such as mowing pastures in which you wish the grass to grow and only the tall weeds to be cut.

Your Gravely dealer will provide you with instructions for installing the Skids on your Sickle Mower.

SICKLE GRINDER

The Gravely Sickle Grinder is a necessity if you do much mowing with the Sickle Mower. The Grinder comes equipped with a three-inch cone correctly beveled to sharpen properly the three-inch Sickle Knives. Two-inch cones are available for two-inch Knives.

In ordering, specify the size Knives your Sickle Mower has.

Instructions are packed with the Sickle Grinder.

50-INCH ROTARY MOWER



The 50-Inch Rotary Mower is designed for fast and efficient mowing of large lawns. It is not designed to mow tall weeds, undergrowth, and other heavy plant matter. If these are on your grounds, we suggest you see your Gravely dealer for a free demonstration of attachments designed for this type cutting, such as the 30-inch Rotary Mower.

LUBRICATION

Check the oil level in the Gear Housing every four hours of operation, by removing the Oil Level Plug, 1 in Figure 12. If oil runs out, the oil level is all right; if not, oil must be added.

To add oil, remove the Oil Filler Plug, approximate location shown by 2 in Figure 12, and pour oil through the Oil Filler Hole. Stop when oil begins to run out the Oil Level Hole. Replace both plugs before mowing.

Use Mobilube EP-140 (SAE 140) in the Gear Housing.

Use Mobilgrease MP every 10 hours in the grease fittings on the Caster Brackets, Caster Wheels, and Swivel Casting, 3 in Figure 12.

Use Mobilgrease MP every 10 hours in the grease fitting on each Spindle Assembly. **Note:** The Spindle Assembly grease fitting is vented to make it impossible to over-lubricate the Spindle Assembly. While greasing, if you observe grease coming out the vent, this means simply that the Spindle Assembly is loaded to capacity with grease.

CUTTING HEIGHT ADJUSTMENT

Cutting height adjustment is made at the Spindle Assemblies on the Spindle Shafts.

Each of the three Blades can be adjusted to cut from one to four inches from the ground. At delivery, the cutting height is set at 2½ inches from the ground. To adjust each Blade:

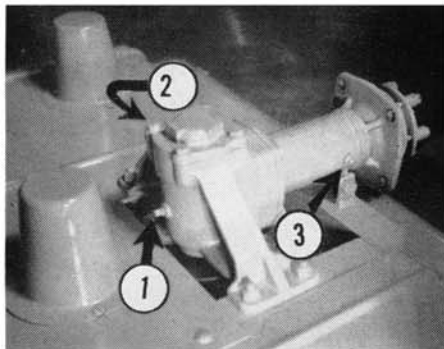

Figure 12

1. Remove the Spindle Cover (the cylindrical cover on top of the Belt Guard) by removing the sheet metal screws which hold it to the Deck.

2. Remove the cotter key from the end of the Height Adjustment Pin, 1 in Figure 13. On the center and right Blades (center and right as you stand at the Handles) the cotter key and Pin are accessible upon removal of the Spindle Covers. However, to gain access to the left Blade cotter key and Pin, reach under the left Belt Guard. An alternate method is to remove the entire left Belt Guard (which includes the Spindle Cover) by unscrewing the machine screws which hold it to the Deck.

3. Insert a screwdriver or similar tool in the large hole at the top of the Spindle Shaft. Using the screwdriver, lift up slightly on the Shaft and remove the Pin.

4. There are six holes in the Shaft (exclusive of the large hole in which the screwdriver was placed) which regulate the cutting height. The topmost hole sets the cutting height at 1½ inches from the ground, the next at two inches from the ground, and so on in ½-inch increments to a maximum cutting height of four inches. Line up the hole corresponding to the desired cutting height with the holes in the Shaft Housing, 2 in Figure 13, and insert the Height Adjustment Pin into these. Then insert the cotter key in the end of the Pin.

5. Replace the Spindle Covers (and the left Belt Guard, if it has been removed).

CUTTING PLANE ADJUSTMENT

The Caster Wheels keep the Mower in a horizontal plane parallel to the ground. When the Caster Wheels are adjusted properly and the three Blades are set at the same cutting height, the Mower cuts smoothly and uniformly throughout its swath.

During operation, should you notice the Mower cutting closer on one side of its swath than on the other, or if the Skids mark the ground with a narrow trench-like depression, this would indicate the Caster Wheels are out of adjustment.

Adjust the Caster Wheels by the four large washers on the Caster Bracket. To raise the Mower, place two, three, or four washers at the bottom of the Bracket; conversely, to lower the Mower, place two, three, or all four washers at the top of the Bracket. If one Skid marks the lawn, raise the Mower by the Caster Wheel nearer it; if both Skids mark the lawn, raise the Mower by both Caster Wheels.

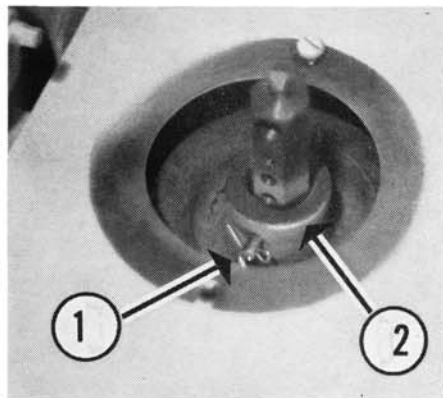

Figure 13

To rearrange the washer combination, place a block under the Skid nearer the Caster with which you are working. Then remove the bolt which secures the Caster Fork to the Caster Bracket. Remove the Caster Wheel and Fork and rearrange the washers as desired. Then reassemble the entire Caster Assembly.

BELTS

The Mower has two Belts: the right Belt (right, as you stand at the Handles), which drives the center and right Blades, and the left Belt, which drives the left Blade. Proper adjustment of the Belts is vital—if too tight, the Belts will wear excessively; if too loose, the Belts will slip, causing the Mower to skip over areas within its swath. Also, if the Belts are not in proper adjustment, the Bearings and Belts will run hotter than normal.

BELT ADJUSTMENT. The Belts are in proper adjustment when the Mower is delivered. Loosening is seldom required, except when replacing a Belt. However, from time to time you will need to tighten the Belts; this is indicated by the Mower skipping over areas within its swath.

The left Belt is adjusted at the left Spindle Assembly, access to which is gained by removing the machine screws which hold the left Belt Guard to the Deck. The right Belt can be adjusted at either the right or center Spindle Assembly, access to which is gained by removing the machine screws which hold the center and right Belt Guards to the Deck. We recommend that adjustment of the right Belt be made at the right Spindle Assembly initially; only if additional adjustment is needed should you adjust at the center Spindle Assembly.

Note: In adjusting the Belts it is possible to pull a Spindle Assembly far enough from its proper position to cause its Blade to strike the adjacent Blade while mowing. When you have adjusted the Belts, always rotate the Blades by hand to make sure there is no Blade interference and to insure there is sufficient overlap to keep from missing areas, especially on turns.

The procedure for tightening each Belt is the same—the Spindle Assembly is moved from the Main Drive Pulley as follows (Refer to Figure 14 for parts identification):

1. Loosen the four nuts which hold the Spindle Assembly and Dust Shield to the Deck. It is not necessary to hold the bolts onto which these are screwed, as they are locked to the underside of the Deck.

2. Back off the Adjustment Lock Nut several turns from the Adjusting Nut Bracket.

3. Tighten the Adjusting Nut against the Adjusting Bracket until proper tension has been applied to the Belt. When the Belt is in proper adjustment, by applying moderate pressure at its midpoint, you should be able to deflect the Belt approximately 1/2-inch.

4. Holding the Adjusting Nut firmly against the Adjusting Nut Bracket, tighten the Adjustment Lock Nut securely against the Bracket.

5. Tighten firmly the four nuts which hold the Spindle Assembly and Dust Shield to the Deck.

In loosening a Belt, the Spindle Assembly is moved toward the Main Drive Pulley as follows (Refer to Figure 14 for parts identification):

1. Loosen the four nuts securing the Spindle Assembly and Dust Shield.

2. Back off the Adjusting Nut several turns from the Adjusting Nut Bracket.

3. Back off the Adjustment Lock Nut from the Adjusting Nut Bracket until proper Belt tension is reached.

4. Holding the Adjustment Lock Nut firmly against the Adjusting Nut Bracket, tighten the Adjusting Nut firmly against the Bracket.

5. Tighten firmly the four bolts securing the Spindle Assembly and Dust Shield to the Deck.

BELT REPLACEMENT. After all possible Belt adjustment has been made, if the Mower continues to skip over areas within its swath, replacement of the appropriate Belt is indicated.

To replace the right Belt (right, as you stand at the Handles):

1. Following "Belt Adjustment" procedures, remove the center and right Belt Guards and move the center and right Spindle Assemblies toward the Main Drive Pulley as far as possible.

2. Remove the right Drive Mount Support Sleeve, 1 in Figure 15. To do this, elevate the Mower sufficiently to enable you to hold the Sleeve Bolt on the underside of the Deck. Remove the nut from the Sleeve Bolt, tap the Bolt free of the Mower, and remove the Sleeve.

3. Slip the Belt from the Main Drive Pulley, Center Spindle Pulley, and right Spindle Pulley, and remove the Belt from the Mower.

4. Place the new Belt on the Pulleys. Replace the right Drive Mount Support Sleeve.

5. Adjust the Belt. When positioned properly on the Pulleys and in proper adjustment, there should be approximately 1/32-inch between the top of the Belt and the top of the Pulley flanges.

6. Replace the Center and Right Belt Guards.

To replace the left Belt (left, as you stand at the Handles):

1. Remove the left, center, and right Belt Guards.

2. To provide clearance for removing the left Belt, the right Belt must be loosened enough to slip it from its groove in the Main Drive Pulley. Normally, the right Spindle Assembly can be moved far enough forward toward the Main Drive Pulley to make this possible. Do not move the center Spindle Assembly unless absolutely necessary. Do not remove the right Drive Mount Support Sleeve.

3. Move the left Spindle Assembly as far forward as possible toward the Main Drive Pulley.

4. Remove the left Drive Mount Support Sleeve, 2 in Figure 15.

5. Slip the Belt from the left Spindle Pulley and Main Drive Pulley, removing it from the Mower.

6. Place the new Belt on the Pulleys and replace the left Drive Mount Support Sleeve.

7. Adjust the Belt. Be sure there is approximately 1/32-inch clearance between the top of the Belt and the top of the Pulley flanges.

8. Make sure the right Belt has been replaced on the Main Drive Pulley and is in proper adjustment before replacing the three Belt Guards.

BLADE SHARPENING

To sharpen a Blade, remove it from the Mower and use the original cutting edges as your guide. After sharpening, test for proper balance by inserting a screwdriver and holding the screwdriver parallel to the ground. If one side of the Blade dips noticeably, that side is too heavy and should be ground further.

OPERATION

We recommend that you mow so the cut grass is discharged (out the left side of the Mower) onto the lawn areas which have not been cut.

CAUTION

Never put your hands or feet under the Deck while the Mower is running, or for an interval after the Mower has been disengaged. Make sure all Blades have stopped before attempting any repair or adjustment to the Mower, and that the attachment is disengaged and the Engine stopped.

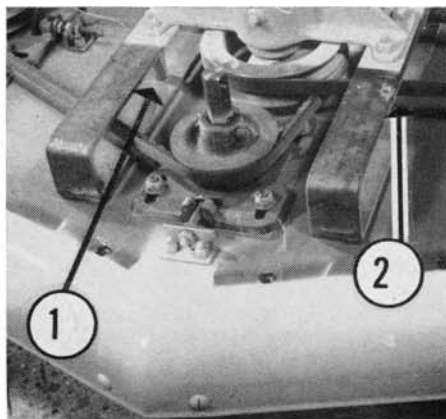

Figure 15

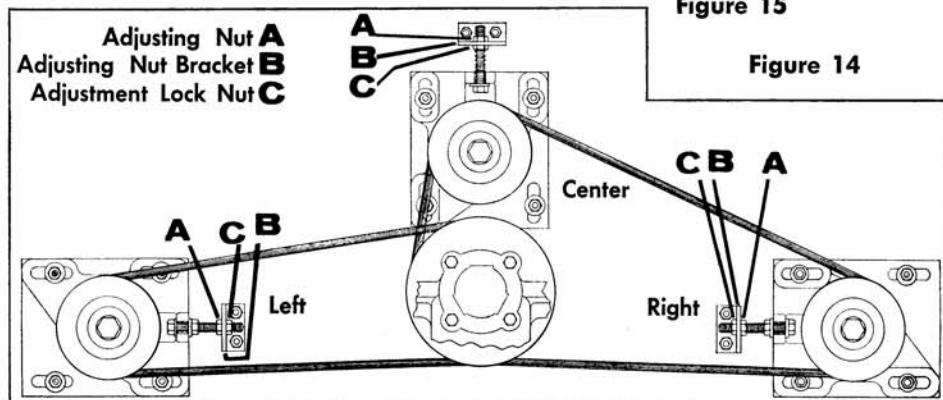
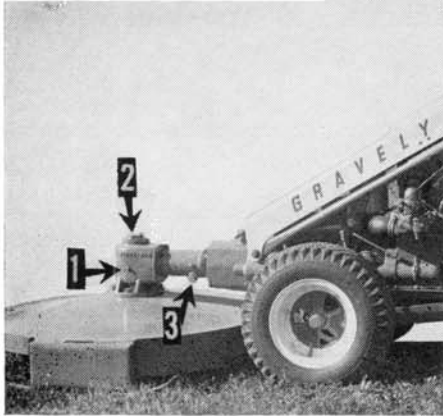

Figure 14

ATTACHMENTS USING 30-INCH ROTARY MOWER DRIVE

VERSATILE. The 30-inch Rotary Mower handles rough and smooth lawns with equal ease... and its Drive powers four other attachments.

Figure 16



In addition to the 30-inch Rotary Mower, four other power attachments use the Drive Assembly shown in Figure 16. These are the Leaf Mulcher, Leaf-Away, Chain Saw, and Circular Saw.

LUBRICATION

Check the Gear Housing oil level every four hours of operation by removing the Oil Level Plug, 1 in Figure 16. If oil runs out, the oil level is all right; if not, oil must be added.

To add oil, remove the Oil Filler Plug, 2 in Figure 16, and pour through the Oil Filler Hole until oil begins to run out the Oil Level Hole. Replace both Plugs before operating.

Use Mobilube EP-140 (SAE 140) in the Gear Housing.

Use Mobilgrease MP occasionally in the grease fittings of the Swivel Casting.

SWIVEL ACTION ADJUSTMENT

Swivel action of the Drive Assembly is regulated by the Swivel Adjustment Bolt and Nut, 3 in Figure 16. Loosening the Adjustment Nut increases swivel action; tightening it decreases swivel action. When using the 30-inch Rotary Mower, Leaf Mulcher, and Leaf-Away, there should be sufficient swivel action to allow the attachment to follow the ground contour with its own weight. When using the Chain or Circular Saw, loosen the Adjustment Nut, turn the Drive Assembly to the desired angle, and tighten the Nut firmly.

30-INCH ROTARY MOWER

To attach the 30-inch Rotary Mower to the Model 106 Drive Assembly, detach the Drive Assembly from the Tractor and turn it upside down so the Oil Filler Plug is on the bottom.

Next, set the Mower Hood in place with the Rear Fender (the taller of the two Fenders) facing the rear of the Drive Assembly.

Place a bolt and plain 1/2-inch washer through each of the six holes in the Hood and Gear Housing flange, with the bolt heads on the under side of the Hood. Place a lock washer and nut on the end of each bolt showing through the Gear Housing flange and tighten each nut securely.

Place the Collars and Blade onto the Rotor Shaft in any order you wish. (See "Cutting Height Adjustment," below.) Be sure the counter-bored sides of the Collars face the Blade. Tighten the nut on the end of the Rotor Shaft securely. **Note:** The Gravelly Triple-Purpose Wrench, available from your Gravelly dealer, is required for the nut on the end of the Rotor Shaft. It also must be used for the Actuating Lever Nut on the Sickle Mower, and Tine Shaft Nut on the Rotary Cultivator.

CUTTING HEIGHT ADJUSTMENT

Cutting height is adjusted by the Collars on the Rotor Shaft. The closer the Blade is to the Gear Housing, the higher the cut, and vice versa. Vary the combination of Collars as you desire, always making sure the counter-bored sides of the Collars face the Blades.

BLADE SHARPENING

Use a file or grindstone to sharpen the Blade. Try to follow the same bevel as the originally-sharpened cutting edge, although the precise degree of bevel is not critical.

FENDER ADJUSTMENT

When mowing short weeds and lawns, the Front Fender (the smaller Fender) must be on front of the Mower Hood, and the Rear Fender (the larger Fender) on the rear.

However, when mowing high, heavy brush, or thick, tough grass of considerable height, better mowing results will be obtained by removing the Front Fender, and replacing it with the optional Chain Guard. See below.

CHAIN GUARD

When the Front Fender is removed, it must always be replaced with the optional Chain Guard. Attached to the Mower by bolts in place of the Front

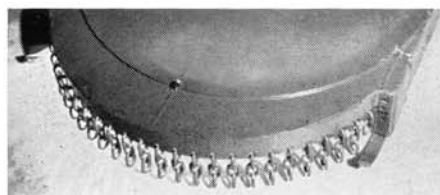

Chain Guard

Fender, the chains reduce the velocity of materials that may be thrown out. It is available from your Gravelly dealer.

CAUTION

Never put your hands or feet under the Hood while the Mower is running, or for an interval after the Mower is shut off. Make sure the Blade has stopped completely, with the Engine off and the Mower disengaged, before attempting any adjustment or repair to the Mower.

• Never operate the Mower unless the Front Fender or optional Chain Guard is on the front of the Mower, and the Rear Fender is on the rear of the Mower.

• When using the 30-inch Rotary Mower, never shift the Inside Operating Lever directly from high to low. Always pause momentarily in neutral, giving the Blade a chance to slow down naturally, thus avoiding the severe braking action from a sudden shift into low gear.

LEAF MULCHER

Attach the Leaf Mulcher to the 30-inch Rotary Mower as follows:

1. Remove both the Front and Rear Fenders. Bolt the Rear Fender to the front of the Mower Hood.

2. Attach the Leaf Mulcher to the rear of the Mower Hood, in the position normally occupied by the Rear Fender.

To operate the Leaf Mulcher, proceed the same as you would in mowing. Normal walking speed is usually adequate to do a good job, although when leaves are wet or packed down, you may have to go over the area twice.

LEAF-AWAY

Instructions for assembling and attaching are packed with the Leaf-Away.

Note: The Leaf-Away can be used only with 30-inch Rotary Mowers whose Blades rotate clockwise (Models 58, 58-A, 106, and 185).

MUFFLER ADJUSTMENT

Remove the Muffler, insert the all-thread Nipple and Elbow, and re-attach the Muffler. Direct the Muffler so the exhaust will hit the asbestos panel on the Pouch. When the Leaf-Away is not being used, the Nipple and Elbow may be removed, and the Muffler placed on the Tractor in the normal manner.

EMPTYING POUCH

To empty the Pouch, simply unsnap the Pouch from the Chute, unhook it from the Pouch Support, and unzip. Contents are easily shaken out.

Note: For use in large areas, such as college grounds, we recommend purchase of additional Pouches. Several filled pouches may be taken in a truck to where the leaves are to be burned.

OPERATING HINTS

- Operate the Leaf-Away with the Tractor in high gear at all times.
- Stoppage caused by leaves and debris blocking the Chute is detected by collapse of the Pouch. To correct, keep the Blowers operating at high speed and work the Chute Cleaner Poker with a vertical motion into the Chute.
- Although the Leaf-Away will function effectively in most cases with only one Mower Blade Blower, we recommend use of both Blowers, especially where leaves and debris have a high moisture content. Also, we recommend you clean your lawn often enough to prevent leaves from becoming packed down by heavy rain or snow, as leaves in this condition increase the chance of Chute clogging.

CHAIN SAW

Before attaching the Chain Saw to the Drive Assembly, make sure you have the proper Chain Saw Bracket for your Drive Assembly. Drive Assembly Models 52 through 58, having a Gear Housing diameter of 2¾ inches, require the Chain Saw Bracket, Part Number CS-101. Drive Assembly Models 58-A and 185, having a Gear Housing diameter of 3¼ inches, require the Chain Saw Bracket, Part Number CS-101-1. A Converting Collar, Part Number CS-331, may be purchased from your Gravely dealer to adapt the Chain Saw Bracket CS-101-1 for use with Drive Assembly Models 52 through 58.

ATTACHING TO DRIVE ASSEMBLY

Attach the Chain Saw to the Drive Assembly as follows:

1. Remove the nut and Collars from the Rotor Shaft.
2. Loosen the Bracket Clamp bolt, 1 in Figure 17, until the Bracket, 2 in Figure 17, will slip onto the Gear Housing (it may be necessary to wedge the Bracket to make it fit). Line the lower edge of the Bracket even with the lower edge of the Housing—not with the fixed Collar. Tighten the Bracket Clamp Bolt to lock the Bracket in place.
3. Loosen the Swivel Adjustment Bolt (on the Drive Assembly) and rotate the Bracket until the Guide Bar, 3 in Figure 17, points straight up. Then tighten the Swivel Adjustment Bolt.
4. Loosen the Clamp Bolts (which hold the Bracket together) enough to allow the Guide Bar to slide back and forth easily. Put the Chain on the Guide Bar, bringing it through the Bracket.
5. Slip the ½-inch Collar onto the Rotor Shaft, with the counter-bored side toward the end of the Shaft. Slip the Sprocket onto the Shaft and put the Chain around the Sprocket. **Note:** On Drive Assemblies 58, 58-A, and 185, when viewed from the end of the shaft, the Sprocket revolves counter-clockwise; on the other Drive Assemblies, the Sprocket revolves clockwise. Be sure the cutting teeth move in the same direction as the Sprocket.
6. Place the ¼-inch and ⅞-inch Collars on the Shaft, making sure the counter-bored sides face the Sprocket. Put the flat washer on the Shaft and tighten the nut firmly.

CHAIN ADJUSTMENT

Turn the Chain Adjusting Screw, approximate location on other side of Guide shown by 4 in Figure 17, clockwise to increase Chain tension. When the Chain is under proper tension, it will be slightly loose on the Guide Bar, but not loose enough to permit it to come out of its slot when grasped firmly and pulled away strongly from the Guide Bar. Excessive tension will cause the Chain to “burn” the Guide Bar.

ANGULAR ADJUSTMENT

To change the position of the Chain Saw in relation to the Gear Housing, loosen the Bracket Clamp Bolt and turn the Saw to the desired position; then tighten the Bracket Clamp Bolt.

To rotate the Drive Assembly, loosen the Swivel Adjustment Nut and move the Drive Assembly to the desired position; then tighten the Nut.

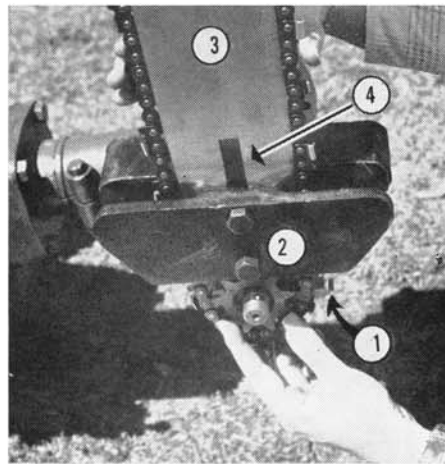

Figure 17

OPERATING HINTS

Best results can be obtained with the Chain Saw if you:

- Always swing the Saw sideways into the tree, letting it “feed” itself naturally by applying only light pressure to the Tractor Handles. Never brace yourself against the Handles to force the Saw into the tree faster than it normally would feed itself. To do so will cause excessive wear of the Chain and Guide Bar, resulting in unsatisfactory operation and a major repair bill.
- Do not cut trees flush with the ground, as this allows dirt to mix with the lubricating oil, forming an abrasive which quickly will wear the Chain and Guide Bar. If you have a large stand of timber to cut flush with the ground, we recommend you fell the trees a few inches from the ground with the Chain Saw, and then use the inexpensive Circular Saw to cut off the small stumps.

GAUGING AND SHARPENING

Proper setting of the Depth Gauges, small projections that control the depth of bite of the Saw, is essential to successful operation. The Gauges are not set at the factory; these must be set in the field. A “Gauge-it” tool is furnished

with each Chain Saw; follow the accompanying directions to set the Depth Gauges properly.

Use the sharpening set, provided with your Saw at no charge, to sharpen the Chain Saw.

LUBRICATION

The Chain Saw has a separate Oiling System which is attached to the Tractor by brackets and clips.

Ordinary motor oil—new or used—may be used in the Oiling System. To operate, simply depress the thumb lever on the can. Use oil liberally during operation.

To disconnect, detach the rubber tube from the copper pipe. The tank and copper pipe may be left on the Tractor if desired.

CIRCULAR SAW

Attach the 18-inch Circular Saw to the Drive Assembly as follows:

1. Remove the Collars and nut from the Rotor Shaft.
2. Place the ⅞-inch and ½-inch Collars onto the Shaft with the counter-bored sides facing the end of the Shaft. Put the Circular Saw on the Shaft, and then the ¼-inch Collar, with the counter-bored side facing the Saw. Tighten the nut securely. **Note:** Cutting edges of the Saw teeth must face in the direction of Shaft rotation. See “Attaching to Drive Assembly” under Chain Saw instructions to determine the direction of Shaft rotation.

OPERATING HINTS

Feed the Circular Saw from the side, just as you would feed the Chain Saw, by exerting slight pressure on the Tractor Handles. Do not force the Saw; let it “eat” into the tree gradually.

- The Circular Saw is most effective for clearing land of saplings, sprouts, and other small growth. We do not recommend the Circular Saw for felling large trees; the Chain Saw does this better and faster.
- Drive the Tractor slowly, swinging the Saw slightly from side to side to clear a wider path. Experience will dictate when it is best to stop your forward motion and concentrate on a sprout or sapling too large to “drive through.”
- Be careful not to run the Saw into the ground or against rocks.

OPTIONAL SAW GUARD

An optional Circular Saw Guard, which attaches to the Gear Housing by a split ring, is available from your Gravely dealer. When ordering, give the model number of your Drive Assembly.

SHARPENING THE SAW

We do not recommend field sharpening. Have this done by someone specializing in circular saw sharpening, or by your Gravely dealer.

STORAGE

When the Circular Saw is to be stored for several days or longer, we recommend you coat it heavily with Mobil-grease MP.

30-INCH REEL MOWER

The 30-inch Reel Mower gives a smooth and uniform cut every time. For the larger mowing jobs, 25-inch Gang Units may be attached to both sides to provide a 75-inch swath.

LUBRICATION

Check the Gear Housing oil level every four hours of operation by removing the Oil Level Plug, 1 in Figure 18. If oil runs out, the oil level is all right; if not, oil must be added.

To add oil, remove the Oil Filler Plug, 2 in Figure 18, and pour through the Oil Filler Hole until oil begins to run out the Oil Level Hole (too much oil will cause over-heating and consequent gear damage). Replace both Plugs before resuming mowing.

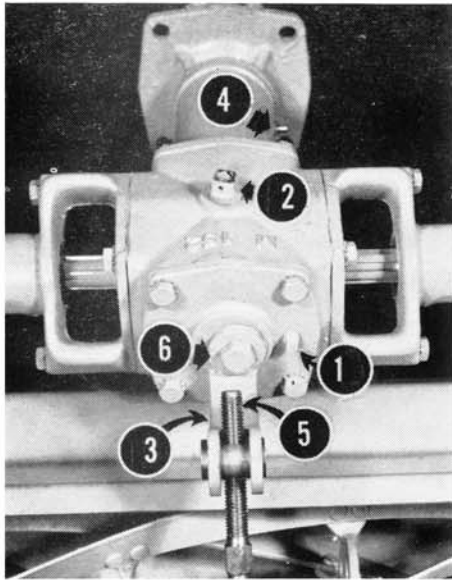

Figure 18

Mobilube EP-140 (SAE 140) is recommended.

Change oil in the Gear Housing at least annually. To drain, remove the entire Strut Casting, 3 in Figure 18; replace after the oil has drained. Add oil as instructed above.

Use Mobilgrease MP occasionally in the grease fittings on the Swivel Casting, 4 in Figure 18, and as required in the grease fittings for the Reel Bearings, arrow in Figure 19. It is important to lubricate properly the Reel Bearings, as the grease forms a water seal around each Bearing, preventing rust. Use Mobilgrease MP as required in the grease fittings on the Roller Bar.

CUTTING HEIGHT ADJUSTMENT

Turn the Height Adjusting Screw, 5 in Figure 18, clockwise to raise the cutting height; turn it counter-clockwise to lower the cutting height.

REVERSE LAPPING OF REEL

The Mower has a special reverse which permits lapping the Reel against the Bed Knife, eliminating in some cases grinding the Reel. The Reel should be lapped any time the adjustment of the

Reel against the Bed Knife is changed radically. To lap the Reel:

1. Loosen the bolt on the front of the Gear Housing, 6 in Figure 18.

2. Slowly roll the Reel back and forth with one hand, pushing the bolt to the opposite side of the Gear Housing with the other. This engages the reverse; when fully engaged, tighten the bolt.

3. With the Mower running at normal speed, carefully use a paint brush to apply a 60-grit lapping compound to the Reel. Allow the Reel to lap in reverse until it makes good contact with the Bed Knife Bar along its entire length.

To put the Reel back into forward, use the above procedure, except push the bolt to the right and lock by tightening.

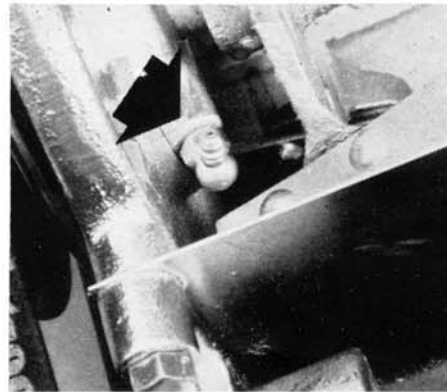

Figure 19

REEL ADJUSTMENT

The Reel must be adjusted properly for the Mower to do a good job.

To test Reel adjustment, place a sheet of paper between the Reel and Bed Knife Bar and turn the Reel by hand. Perform this test at several points along the Bar.

If the paper is cut cleanly each time, the Reel is in proper adjustment. If not, the adjustment is too loose and must be corrected by moving the Reel closer to the Bed Knife Bar. **Note:** If the Reel contacts the Bar (this will seldom occur), the adjustment is too tight and must be corrected by moving the Reel away from the Bar.

Figure 20

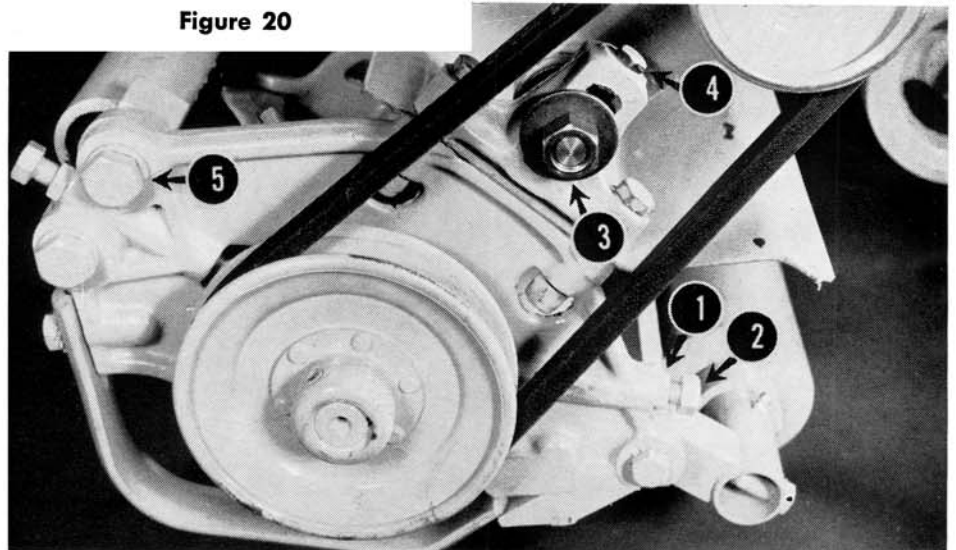

The Reel is adjusted by the Adjustment Lock Nut, 1 in Figure 20, and the Reel Adjusting Bolt, 2 in Figure 20. To move the Reel closer to the Bar, loosen the Adjustment Lock Nut and turn the Reel Adjusting Bolt counter-clockwise; to move it from the Bar, turn the Reel Adjusting Bolt clockwise.

Adjustment can be made at either side of the Reel. If, for example, facing the Reel you find the paper is not cut cleanly on the right side, loosen the Adjustment Lock Nut on the right side and turn the Reel Adjusting Bolt counter-clockwise. Then loosen the Adjustment Lock Nut on the left side and turn the left Reel Adjusting Bolt clockwise slightly. Test. Repeat if necessary. Tighten the Adjustment Lock Nuts to hold the adjustment.

BELTS

Power is transmitted from the Gear Housing to the Reel by means of a V-Belt at each end of the Reel.

ADJUSTMENT. Both Belts are in proper adjustment when moderate pressure applied to the mid-point of each Belt will deflect it approximately one inch.

To tighten a Belt, loosen the Belt Adjusting Nut, 3 in Figure 20, and turn the Belt Adjusting Bolt, 4 in Figure 20, clockwise. To loosen, turn the Adjusting Bolt counter-clockwise. After proper adjustment is reached tighten the Adjusting Nut.

If the Adjusting Bolt has been turned clockwise as far as possible and the Belt does not tighten, the Belt should be replaced.

INSTALLATION. To install a new Belt, turn the Height Adjusting Screw until it releases the Reel Assembly from the Gear Housing Strut. Raise the Mower slightly and swing the Reel toward the Tractor until the Belts are loose on the Pulleys. Remove the old Belt and replace with the new one. With the new Belt in place, return the Reel Assembly to the normal position, replace the Height Adjusting Screw, and adjust the Mower to the proper cutting height.

Make sure the newly-installed Belt is in proper adjustment.

25-INCH GANG UNITS

The first step in attaching the 25-inch Gang Units to the 30-inch Reel Mower is to attach the Power Take-off to the Swivel Casting (of the Drive Assembly) as shown in Figure 21.

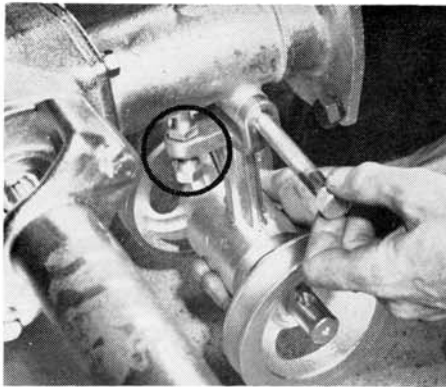

Figure 21

Next, a Belt for each Gang Unit must be attached to the Power Take-off as follows:

1. Remove the Belts from the 30-inch Reel Mower, following procedures outlined above.

2. Loosen the set screws and remove the Outer Drive Pulley, 1 in Figure 22.

3. Loosen the Bearing Cap Screw, 2 in Figure 22, and pull the Outer Cross Shaft, 3 in Figure 22, out as far as possible so there is room to insert the Inner Wing Drive Pulley and Belt into the opening, 4 in Figure 22.

4. Replace the Outer Cross Shaft, engaging it with the Inner Drive Pulley and tightening the set screw on this Pulley. Replace all parts.

Next, attach the Leader, 1 in Figure 23, as follows:

1. Remove the top Tie Rod Bolt, 5 in Figure 20, replacing it with the Leader Pivot and Stud, as shown in Figure 23.

2. Attach the Leader Swivel to the Leader Pivot by using the Leader Swivel Pin, 2 in Figure 23. On new equipment, the Leader Swivel Pin may not fit easily because of paint on the Pin and inside the holes into which it fits. Use fine emery paper to remove the paint.

Finally, attach the Universal Assembly, 1 in Figure 24, as follows:

1. Place the Wing Spider, 2 in Figure 24, in position against the Reel Bearing. Tighten the set screws.

2. Grasp the Locking Ring, 3 in Figure 24 (pulling back against its spring), and place it against the Lower Take-off Shaft, lining up the Locking Ring balls with the holes in the Shaft.

3. Release the Locking Ring to lock the Universal Assembly securely in position against the Power Take-off.

ADJUSTMENTS AND LUBRICATION. With the following exceptions, all ad-

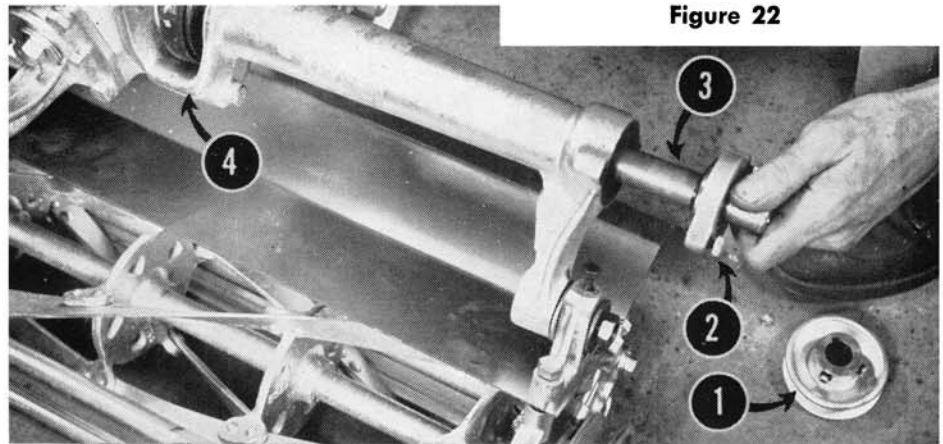
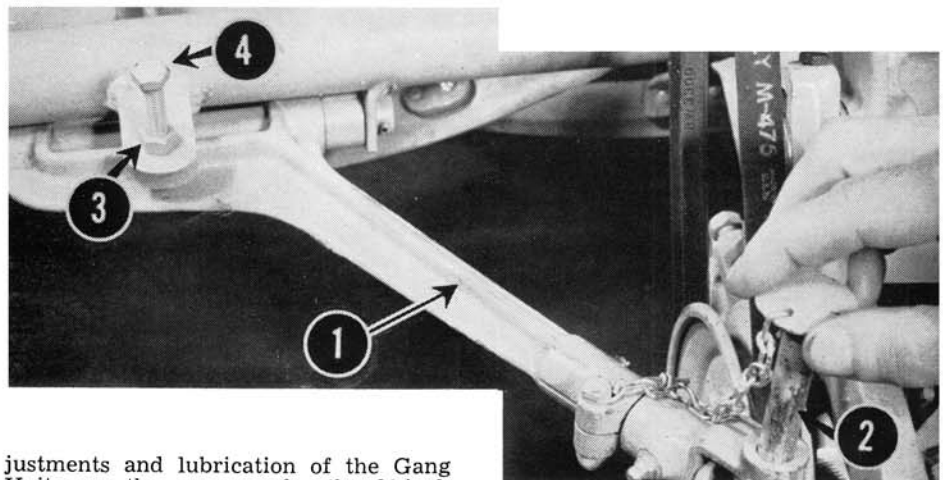

Figure 22



justments and lubrication of the Gang Units are the same as for the 30-inch Reel Mower:

BELTS. Belt tension is adjusted by the Belt Adjusting Screw and lock nut, circled in Figure 21. To increase tension, loosen the Lock Nut and turn the Adjusting Screw clockwise; to decrease tension, turn the Adjusting Screw counter-clockwise. When proper tension is reached (as with other Belts, proper adjustment is when moderate pressure applied to the mid-point of the Belt will deflect it approximately one inch) tighten the Lock Nut.

LEADERS. For best results adjust the Leaders so the Gang Units will run parallel with the 30-inch Reel Mower.

CUTTING HEIGHT. To adjust the cutting height, loosen the lock nut, 3 in Figure 23, and turn the Height Adjusting Screw, 4 in Figure 23, clockwise (to increase cutting height) or counter-clockwise (to lower cutting height). Tighten the lock nut when proper adjustment is reached.

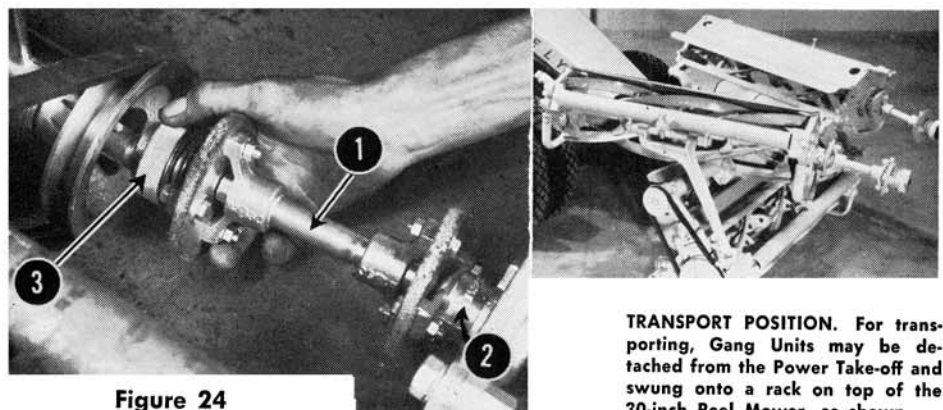

Figure 24

TRANSPORT POSITION. For transporting, Gang Units may be detached from the Power Take-off and swung onto a rack on top of the 30-inch Reel Mower, as shown.

TWIN-TOOL POWER GARDENING— ROTARY PLOW AND ROTARY CULTIVATOR

OPERATING INSTRUCTIONS



To plow your land, first run a furrow down the center of the land to be plowed. Then pivot the Tractor at the end of the furrow so the Right Depth Wheel is in the furrow just made. Continue this way so the dirt is always thrown toward the center (see Figure 27).

If you are plowing a large area, you will be able to "pull" the Tractor around corners without pivoting. However, in small areas it is necessary to pivot the Tractor each time.

Pivoting is made easier by observing the following: When you are ready to pivot, bear down on the Handles until the Tractor is balanced. "Slip" the Clutch gently, holding back on the Right Handle, allowing the Engine to pivot the Tractor with little effort on your part.

Plowing is much easier if the Gear Housing is kept level with the ground when the Plow is in the furrow and plowing. To do this, try to obtain all depth adjustment by the holes in the Hex Shaft, and the horizontal adjustment by moving the Wheel Bracket laterally.

If you have the eight-speed Transmission, we recommend plowing with the Tractor in low range, which slows ground speed to a virtual crawl without affecting attachment RPM. In effect, this lets the Rotary Plow strike the soil twice as often per foot traveled by the Tractor. If you have the Standard Transmission, we recommend use of Gravely Gear Reduction Wheels, shown on Page 6, for use in tough soil. This accessory gives the Standard Transmission virtually the same ground speed as obtained by the eight-speed Transmission's low axle range. Your Gravely dealer will be glad to recommend and demonstrate plowing accessories for you.

ROTARY PLOW

The Rotary Plow is attached to the Tractor by four bolts. Two bolts must be used to attach the Angle Adjusting Bracket, upper left in Figure 25.

LUBRICATION

Check the Gear Housing oil level every eight hours of operation. Gear Housing oil capacity is 1½ pints. Use Mobilube EP-140 (SAE 140).

Add oil by removing the Oil Filler Plug, 1 in Figure 25.

To drain old oil, loosen the Angle Adjustment Bolt (which fits in the Angle Adjustment Bracket) and turn the attachment upside down. Remove the Oil Filler Plug.

Replace the Oil Filler Plug after new oil has been put into the Gear Housing.

Use an occasional shot of Mobilgrease MP in the swivel casting grease fitting, 2 in Figure 25.

DEPTH OF CUT ADJUSTMENT

Use the pin or clip, 3 in Figure 25, in the Hex Shaft for initial cutting depth adjustment. The higher on the Shaft the Pin is inserted, the lower the depth of cut and vice versa. Ordinarily, the Pin is inserted in the topmost hole for plowing and in the bottom hole for transporting.

A final cutting depth adjustment, if required, is made by sliding the Wheel Bracket Clamp, 1 in Figure 26, up or down in the slotted Wheel Bracket. The lower the Clamp is set, the lower the depth of cut.

PLOWING ANGLE ADJUSTMENT

When plowing for the first time, set the Plow at the approximate angle to the ground as shown in Figure 26. The nut which secures the Angle Adjustment Lever must be loosened to do this; be sure it is tightened firmly after the proper angle is set.

If there is excessive drag to the left (left, as you stand at the Handles) move

the Plow in the direction of the arrow in Figure 26. If there is excessive drag to the right, move the Plow opposite the direction of the arrow.

A few trials may be required before the Plow is adjusted properly to soil conditions.

WIDTH OF CUT ADJUSTMENT

The width of cut is governed by the position of the Wheel Bracket in relation to the Depth Wheel in the furrow. The closer the Wheel Bracket is to the Depth Wheel in the furrow, the narrower the cut, and vice versa.

DIRT SHIELD

The optional (at no extra cost) Dirt Shield is attached to the top of the Gear Housing by removing the bolts, 4 in Figure 25, inserting them through the Shield, and replacing in the Gear Housing. You can use the Dirt Shield to direct the throw of the dirt, by bending it up or down.

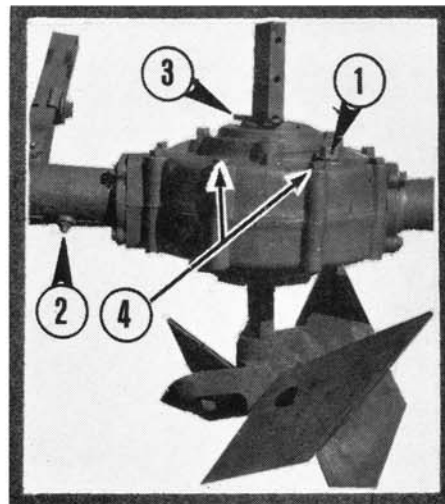

Figure 25

OTHER ROTARY PLOW USES

In addition to routine plowing, the Rotary Plow can be used for:

DITCHING. Best results are obtained by using the special long Hex Shaft, which is available from your Gravely dealer. Use the Adjusting Handle to turn the Plow at a fairly large angle from the vertical, so the dirt will be thrown from the ditch. Straddle the cut you are making with the Wheels. Make the first pass fairly shallow; on succeeding passes drop the depth of cut lower each time until the desired depth is reached.

PLANTING TREES AND SHRUBS. Remove the Depth Wheels and Wheel

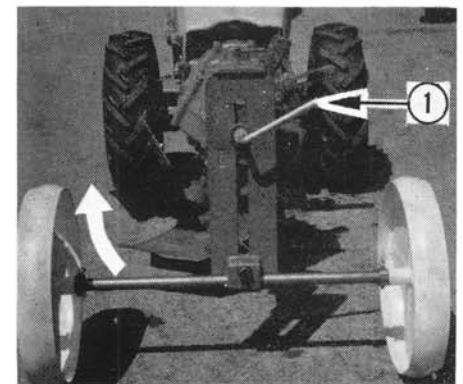

Figure 26

Bracket from the front of the Rotary Plow. Take the Adjusting Handle loose from the Angle Adjustment Bracket and turn the Shaft until it is vertical. Spot the Plow where you want the hole, put the Plow in gear, and let it eat its way down. It prepares a hole suitable for evergreens and other small trees and shrubs.

MAKING HILLS. Use the Rotary Plow as follows to make hills for sweet potatoes and other crops: With the Dirt Shield bent downward so the dirt cannot be thrown farther than a foot, make a furrow at the exact location where you want the center of the hill. At the end of this furrow, pivot the Tractor and make a second furrow (the Plow will throw the dirt to the right, forming one

side of the hill). At the end of the second furrow, again pivot the Tractor and make another furrow to the right of the first furrow (the Plow will throw the dirt to the right, forming the other side of the hill).

1. Start.
2. Pivot and set right wheels in first furrow.
3. Pivot and again set right wheels in first furrow.
4. Keep right wheels in each succeeding furrow.

Figure 27

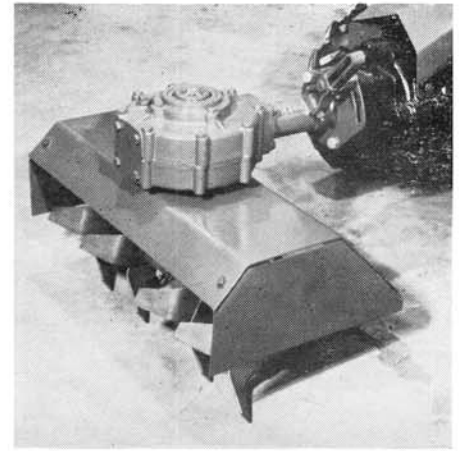
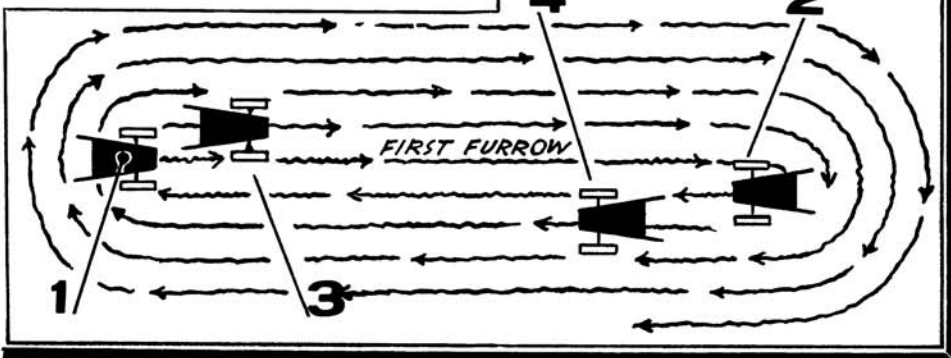

Figure 29

Spacers (cylinders) over the studs and secure in place with the stud nuts.

OPERATING HINTS

The Rotary Cultivator is designed for cultivating soil which has been broken previously. It is not recommended for use as a plow. Use the Gravely Rotary Plow to prepare a perfect seedbed in one operation and the Rotary Cultivator for perfect cultivation throughout the season.

- Cultivating depth is controlled by light pressure on the Handles. When the Tines are set to move clockwise—as they usually are—depth is controlled generally by the design of the Cultivator itself, about three inches.

- To cultivate slightly deeper than this, raise up on the Handles; conversely, to cultivate shallower than three inches, place slight pressure on the Handles.

- Direction of Tine rotation also controls the depth of cultivation. As a general rule, to obtain greater depth, when attaching the Cultivator to the Gear Housing, rotate it 180° so the Tines revolve counter-clockwise, rather than clockwise, when the Tractor moves forward. When used in this manner, we recommend use of the Rotary Plow Depth Wheel Assembly to keep the Cultivator from “digging in” and stalling the Tractor.

- When cultivating crops such as corn, which usually require some dirt thrown around the plants, remove the End Plates. In other instances, such as cultivation of bushy crops, keep the End Plates attached to the Hood.

ROTARY CULTIVATOR

The Rotary Cultivator is attached to the Rotary Plow Drive Assembly as follows:

1. Leave the Plow Angle Adjusting Assembly (upper left in Figure 25) attached.

2. Remove the Hex Shaft (and Plow Blades) from the Gear Housing.

The Depth Wheels, Wheel Bracket, and Column Assembly (which connects the Wheel Bracket to the Gear Housing) may be removed, as these serve no useful purpose unless you wish to operate the Cultivator with the Tines cutting against the motion of the Tractor (see “Operating Hints”).

Note: After the Column Assembly has been removed, bolts must be inserted into the Gear Housing to prevent oil leakage. We recommend short bolts for this purpose; if the original bolts are tightened, the gears inside the Gear Housing will be fouled. If, however, you use the original bolts, place sufficient washers on them to prevent gear fouling.

3. Rotate the Gear Housing 180° so the Oil Filler Plug is on the bottom. Remove the four bolts from the bottom of the Gear Housing and insert the studs furnished (If you do not have a stud driver, two nuts may be locked together on the threads and used to seat the studs; remove the nuts after seating the studs).

4. Fit the Hood as shown in Figure 28. Insert the Cultivator Drive Shaft into the Gear Housing.

5. Use the elastic stop nuts to fasten the Cultivator Drive securely to the Gear Housing.

6. Rotate the Cultivator to the position shown in Figure 29. In this position the Tines will cut in the same direc-

tion (clockwise) as the forward movement of the Tractor.

7. Install the Dust Shield and Fastener on top of the Hex Shaft.

8. Use the Adjusting Bracket to lock the Cultivator in place with the long axis of the Cultivator parallel to the Tractor Axles.

Note: The Gravely Triple-Purpose Wrench, available from your Gravely dealer, is required for the Cultivator Tine Shaft Nut.

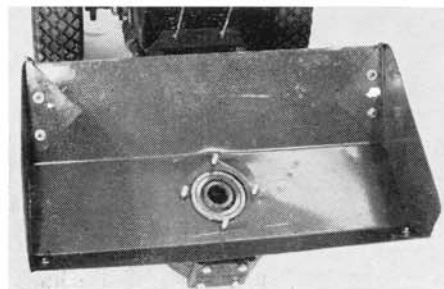

Figure 28

LUBRICATION

Check the Cultivator Drive Assembly oil level every eight hours of operation by removing the Oil Level Plug, 1 in Figure 30. If oil runs out the Oil Level Hole, the oil level is all right; if not, oil must be added.

To add oil, remove the Oil Filler plug, 2 in Figure 30, and pour through the Oil Filler Hole until oil begins to run out the Oil Level Hole. Replace both Plugs when proper oil level is reached.

Use Mobilube EP-140 (SAE 140). Be sure the Cultivator is level when checking or adding oil.

STORAGE

When the Cultivator is detached from the Drive Assembly, place the small

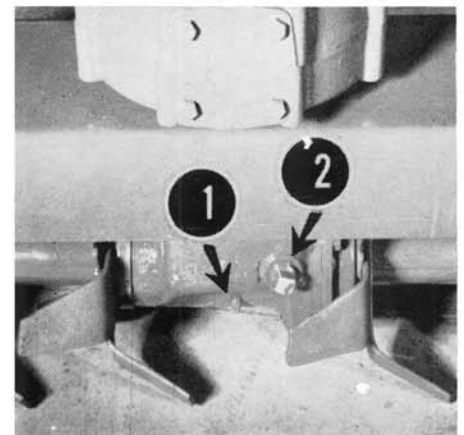

Figure 30

SNOWBLOWER

The Deluxe Snowblower clears a 26-inch swath, blowing snow up to 30 feet away through a Discharge Spout that is adjustable throughout a 180° horizontal arc and a 90° vertical arc. It is powered through a fully-enclosed, all-gear drive—no belts or chains to freeze or break.

LUBRICATION

Check the Gear Housing oil level by removing the Oil Level Plug (the smaller Plug on the Gear Housing). If oil runs out, the oil level is all right.

If oil does not run out, remove the



Oil Filler Plug (the larger Plug) and add Mobilube EP 80-90 (SAE 80-90) until oil begins to run out the Oil Level Hole. Replace both Plugs before operating.

Use Mobilgrease MP occasionally in the grease fitting on the Swivel Casting.

Use light oil as required for the Cog Shaft, pouring through the hole in the Cog Shaft Housing, arrow in Figure 31.

ATTACHING

The Snowblower Swivel Casting is attached to the front of the Tractor by four bolts, the same as with any other power attachment.

Attach the Discharge Spout adjusting mechanism as follows:

1. Attach the Universal Joint, 1 in Figure 31, to the Cog Shaft, 2 in Figure 31, using the roll pin provided.

2. Attach the Universal Joint to the Control Rod, 3 in Figure 31, using the roll pin provided.

3. Attach the Control Rod to the Tractor Handle as shown in Figure 32.

ADJUSTMENTS

For horizontal adjustment of the Discharge Spout, turn the Control Rod Crank at the rear of the Tractor.

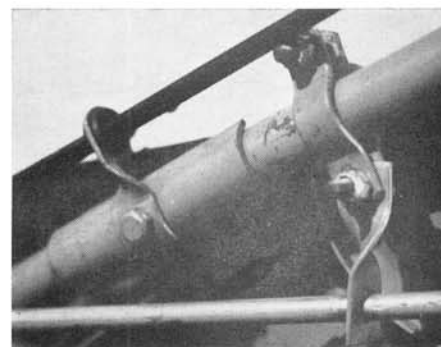

Figure 32

tual crawl, but permits the Snowblower to run fast in direct relation to Engine RPM.

- If you have Standard Transmission, you will have to shift between high and low in keeping with snow depth and density. For extended operation in heavy snows, we recommend use of the Gravelly Gear Reduction Wheels, shown on Page 6.

- If the Tractor stops suddenly while operating the Snowblower, check the vent in the Fuel Tank Cap. Sometimes snow will clog this small opening, especially on older Tractors with Hoods that do not cover the Fuel Tank. We recommend use of anti-ice fuel additives and keeping the Fuel Tank as full as possible at all times to minimize condensation and subsequent fuel line or Carburetor freezing.

- There are several silicon-base products available which you can use to coat the working surfaces of the Snowblower, making it more difficult for snow and ice to adhere to these parts.

- The Snowblower should be raised, by adjusting the Casters, as far off the ground as possible when working on gravel and other non-paved surfaces. This minimizes chances of rocks and other objects being picked up and hurled—with dangerous velocity—by the powerful Snowblower.

Loosen the large wing nuts to adjust the Discharge Spout vertically. See the caution on this page.

The Snowblower can be raised or lowered by adjusting the Casters. Slotted Caster Brackets facilitate moving the Casters up or down.

OPERATING HINTS

Keep the Engine under full load when using the Snowblower. With the eight-speed Transmission, use low axle range—which slows ground speed to a vir-

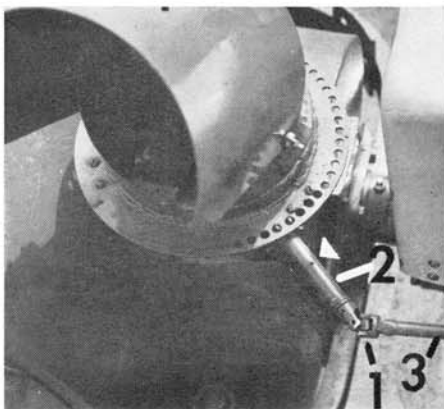

Figure 31

CAUTION

With the Deluxe Snowblower, only one adjustment can be made safely with the attachment running: the Discharge Spout can be adjusted horizontally by turning the Control Rod Crank at the rear of the Tractor.

- To adjust the Discharge Spout vertically (on both the Deluxe and old models), disengage the attachment and wait until the Fan and Reel both are stopped fully.

- For any other adjustment or repair, disengage the Snowblower and stop the Tractor Engine. Be sure the Snowblower has stopped completely.

- Use extreme caution when operating on gravel and other non-paved surfaces. The Snowblower can pick up and expel a heavy rock with sufficient velocity to injure persons or damage property. Casters should always be used for work on non-paved surfaces, and care should be exercised in selecting the direction of the Discharge Spout.

OLDER MODEL SNOWBLOWERS

If you have the older model Snowblower, shown in Figure 33, lubricate the Gear Housing and Swivel Casting as explained above.

To adjust the Discharge Spout, loosen the Clamp and Handwheel, arrow in Figure 33. Tighten when the desired

angle is reached. Observe the caution on Page 18.

Optional Casters are available from your Gravely dealer. These give the Snowblower more stability, and permit it to be raised farther off the ground for safer operation on gravel and other non-paved surfaces.

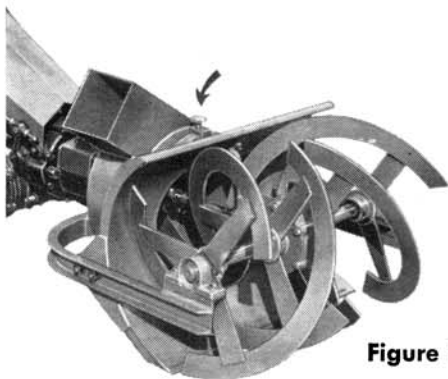

Figure 33

POWER BRUSH

The Power Brush is a useful tool for cleaning parking lots, drives, sidewalks, and other areas where power sweeping is necessary. The Brush can be used for sweeping light snows—up to six inches in depth—clean to the pavement unless there is an ice skim on the pavement.

LUBRICATION

Check the Drive Assembly oil level every eight hours of operation by removing the Oil Filler Plug, 1 in Figure 34, and observing whether the gears dip halfway in the oil.

Add oil, if necessary, through the Oil Filler Hole. Use Mobilube EP-140 (SAE 140).

Be sure the Tractor and Brush are level when checking or adding oil.

Use Mobilgrease MP in the grease fitting (or grease cup) on the Drive

Assembly (this is close to the point where the Drive Assembly is attached to the Tractor).

ADJUSTMENTS

To adjust the Chains, simply remove a half link when the Chain has been driving long enough to "stretch." This usually occurs after several months of use.

To adjust Brush contact, put the Brush in contact with the ground by lifting up on the Brush Contact Lever, 2 in Figure 34. Then turn the Brush Tension Adjusting Bolts, 3 in Figure 34, until proper tension is reached.

Proper Brush tension must be learned by experience. The Brush, of course, must be placed under sufficient pressure to enable it to sweep clean. Always adjust Brush tension downward until correct tension is obtained. **Note:** Too much pressure will cause the Brush Strips to wear out prematurely.

REVERSING OR CHANGING BRUSH STRIPS

When it appears the Brush Strips have worn more on one side than on the other, it is time to reverse the Strips in the Brush Spiders. To do this, loosen the bolts which hold the Strips in the Spiders and remove the Strips. Then reverse the Strips (or replace, when necessary, with new Strips obtained from your Gravely dealer) and tighten the bolts. Adjust to proper tension following procedures outlined above.

TRANSPORTING THE BRUSH

To save unnecessary wear on the Brush strips when going to or from a job, push down on the Brush Contact Lever to raise the Brush off the ground.

Brush life will be increased greatly by wetting the Brush Strips before use, and keeping them wet during prolonged use.



← Power Brush

Figure 34

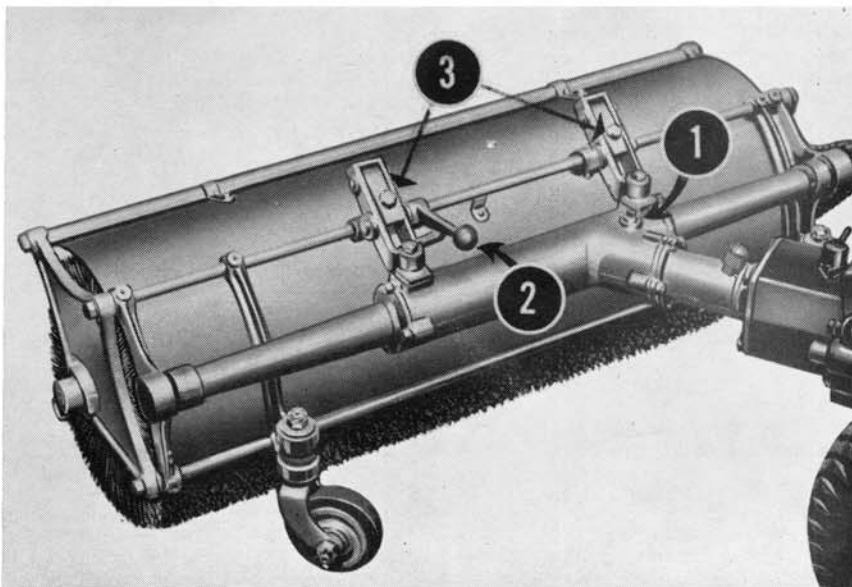

Gravely Non-Power Attachments

CULTIVATOR TOOL HOLDER

The Cultivator Tool Holder, shown in Figure 35, can be used to hold a variety of cultivating tools. The most common set-ups of cultivating tools in the Tool Holder are shown on the opposite page.

In addition, the Cultivator Tool Holder is used to hold the 36-inch Scraper Blade.

ATTACHING TO TRACTOR. The Tool Holder is attached to the front of the Tractor by four bolts, as are power attachments. The Attachment Clutch Lever (or Attachment Clutch Control) should be at the OUT position.

ATTACHING TOOLS TO TOOL HOLDER. The individual cultivating tool, 1 in Figure 35, is attached to a Shank, 2 in Figure 35, which in turn is attached to the Tool Holder by a Shank Holder, 3 in Figure 35.

The Tool Holder comes from the factory with five Shank Holders. These may be moved to different positions on the Tool Holder, if desired, although this is seldom necessary. Additional Shank Holders may be purchased from your Gravely dealer.

Cultivating tools are divided into two classes—those requiring the one-hole Shank and those requiring the two-hole Shank. With the exception of the Furrowers, Hillers, Shovel Steel, and Turning Shovel, cultivating tools require the one-hole Shank.

To attach a tool to its Shank, simply bolt it in place with the nuts and bolts provided.

To attach the Shank to the Tool Holder, loosen the hexagon-head cap screw in the side of the Shank Holder, slip the Shank into the Shank Holder from the bottom, and lock the Shank in place at the desired position by tightening the cap screw.

CHANGING TOOLS. After the Shanks have been attached to the Tool Holder, changing cultivating tools requires only the unbolting of the old tool from its Shank and bolting the new tool on. However, if the new tool requires a two-hole Shank in place of a one-hole Shank, the Shank also must be changed.

PARALLEL BARS. The Parallel Bars, 4 in Figure 35, can be adjusted in several ways, depending on the task. Usually it is necessary to detach the Bars from the Depth Wheels to make these different set-ups.

ADJUSTMENTS. The Depth Wheels are used to set the depth the cultivating tools penetrate the ground. Facing the Depth Wheels, turn the Handwheels clockwise for deeper cultivation and counter-clockwise for shallower cultivation.

Usually the Depth Wheels provide all the adjustment required. However, if

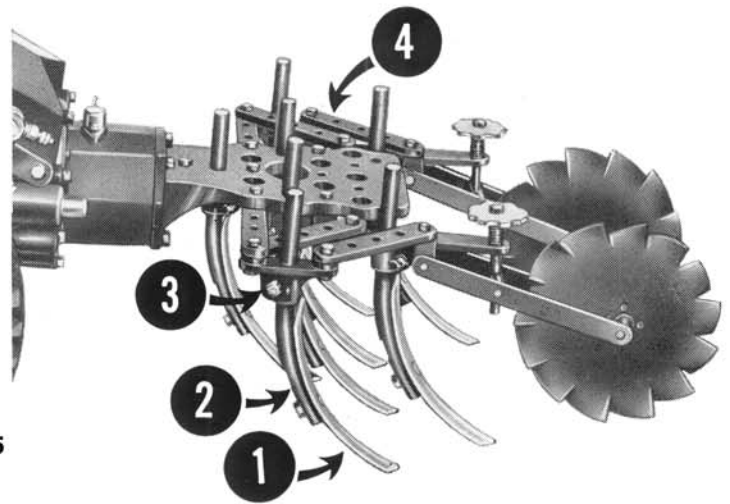

Figure 35

required, the Shanks can be moved up or down in the Shank Holders for additional adjustment.

LUBRICATION

No lubrication is required.

OPERATING HINTS

Individual problems and preferences usually will govern the cultivating depth and how close to the plants you cultivate. However, these suggestions generally will be helpful:

- Cultivating depth within the path of the Tool Holder may be adjusted by the individual Shanks. For example, Shanks may be set for deep cultivation in the center, while barely stirring the dirt next to the plants. This cuts down on hand-hoeing, and does not damage the plants when done with care.

- Rows should be planted enough apart to accommodate the Tractor and Tool Holder. Normal distance between rows is 32 to 36 inches. Rows should be planted farther apart for plants which spread widely, unless you intend to shield the Tool Holder so plants will not be damaged.

- The Tool Holder and cultivating tools are very useful for stirring up deep litter in brooder houses.

- When cultivating very hard or stony ground, place a 50-pound sandbag on the Tool Holder to keep it from bouncing. Use of the sandbag makes no appreciable difference in the handling of the Tractor.

Note: Users sometimes ask us why the Tool Holder is not made heavy enough so use of the 50-pound sandbag is not necessary. To make the Tool Holder 50 pounds heavier would require a price increase of \$18 to \$22. We believe users' interests are served better by recommending this simple and inexpensive way to obtain the needed weight, when necessary, rather than forcing users to pay more money unnecessarily for the attachment.

See Page 22 for Rear Cultivator Tool Holder.

SCRAPER BLADE

The Scraper Blade, not illustrated, is useful for small grading jobs, such as smoothing seedbeds and removing light snowfalls from walks and driveways.

It is attached to the Cultivator Tool Holder by one-hole Shanks.

No lubrication is required.

48-INCH SNOWPLOW

The 48-inch Snowplow clears the average walkway in one pass, the average driveway in two. It moves snow as deep as 18 inches. Key to its efficiency is its unique design—instead of pushing the snow, the Snowplow rolls it out of the way.

The Snowplow has many uses in addition to removing snow. These are discussed under "Additional Uses."



Snowplow

ADJUSTMENTS. The current Snowplow has a Swivel Casting (the Swivel Casting is the part which is attached to the front of the Tractor) which has three holes in it. The Snowplow can be adjusted so there is swivel action, allowing the Blade to follow closer the ground contour, or it can be set so the Blade is held rigidly.

The older Snowplow does not have this swivel action feature; its Swivel Casting has only one hole.

Both models can be adjusted to roll the snow straight ahead or to the left or right.

To set the new Snowplow to roll straight ahead with swivel action, line up the center hole in the Swivel Bracket with the center hole in the Swivel Casting and insert the T-shaped Adjusting Pin. To hold the Blade rigidly in the straight-ahead position, insert the Pin in the holes on either side of the center holes.

To roll snow to the left with swivel action, line up the left (left, as you stand at the Handles) hole in the Swivel Bracket with the center hole in the Swivel Casting and insert the Pin. To hold the Blade rigidly in the left position, insert the Pin in the holes immediately to the right.

To roll snow to the right with swivel action, line up the right (right, as you stand at the Handles) hole in the Swivel Bracket with the center hole in the Swivel Casting and insert the Pin. To hold the Blade rigidly in the right position, insert the Pin in the holes immediately to the left.

On the older Snowplow, simply move the Blade to the desired position, line up the holes in the Swivel Bracket with the hole in the Swivel Casting, and insert the Pin.

WEARING STRIP. The Wearing Strip on the bottom of the Blade eventually will have to be replaced. To replace, simply remove the screws, take off the old Strip, put the new Strip on, and tighten the screws firmly.

SKIDS. Skids, available from your Gravely dealer, are useful when working on concrete drives where one side is higher than the other (thus forming an edge which would catch the Blade) and on gravel or bluestone drives to keep the Blade high enough to remove the snow without removing the gravel or stone.

To attach the Skids, remove the end screws from the Wearing Strip and insert the long bolts provided with the Skids. Slip the Skids onto the bolts from the rear of the Blade, with the long sides down and parallel to the ground. Fasten the nuts securely on the bolts.

RECOMMENDED ACCESSORIES. Gravely Tire Chains (see Page 6) are helpful when removing snow from ice-coated pavements. When using the Snowplow for light bulldozing, the Dual Wheels described on Page 5 in many cases may be desirable.

LUBRICATION. No lubrication is required.

ADDITIONAL USES. The Snowplow is used by many landscapers in combination with the Rotary Plow and Rotary Cultivator to prepare lawns for seeding. After plowing, the Snowplow can be used to terrace and grade. Many users go over the area to be seeded with the Tractor in reverse, so that the Snowplow follows the Tractor. This makes a smooth, even seedbed properly prepared

COMMON CULTIVATING TOOL SET-UPS

FIVE-STEEL SET-UP is the standard arrangement; 1¼-inch wide Steels are used. Figure 35 shows a slight modification of this set-up, in which seven Steels are used. Steels are available in 1¼, 1¾, and 2¼ inch widths; standard length of the Steels is eight inches.



SIX-INCH HILLER SET-UP uses right and left Hillers; these can be used for closing rows as well as for hilling. Hillers can be used to throw dirt away from or around the plants as desired. A furrower, available in 10 or 12-inch depths, can be used with the Hillers to bring dirt from the center of the row to the Hillers, which in turn throw dirt around the plants.

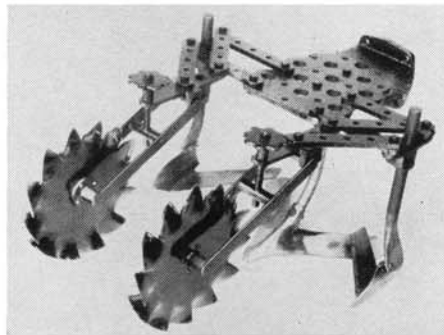

for seeding. In some cases, after seeding the Snowplow is used in the same manner, thus setting the seeds at approximately the right depth for good germination.

- Dairy farmers use the Snowplow to clean concrete holding pens. Some even take the Tractor inside barns to scrape out manure and litter.

- Poultry farmers find the Snowplow useful for cleaning the inside of brooder houses of litter and droppings.

- Owners of motels, parking lots, and drive-in theatres use the Snowplow in reverse to level gravel and slag driveways.

- Industrial users employ the Snowplow in unloading bulky materials (such as sand and gravel) from barges. After the clamshell has unloaded most of the material, the Tractor and Snowplow can be lowered into the barge to scrape up the remaining material into piles large enough for the clamshell to pick up.

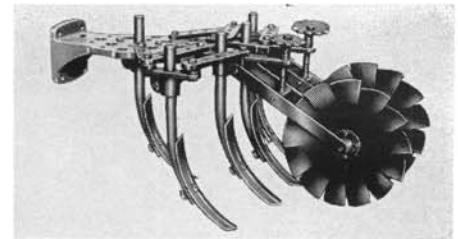

SEVEN-STEEL V SET-UP uses one Depth Wheel with the Parallel Bars arranged to form a V. The Tool Holder follows the ground contour closely, with the two outside Steels shielding foliage and vine crops to prevent damage by the Tractor Wheels.

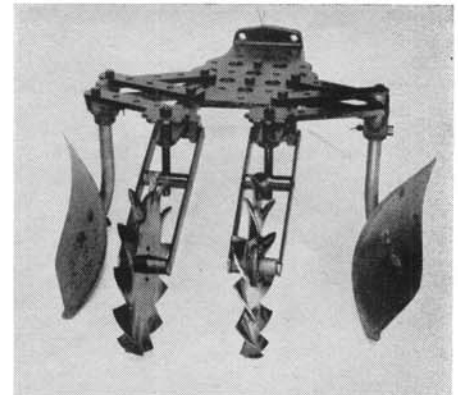

SWEEP AND HOE SET-UP uses an improved Sweep in the center and a right and left Gravely Hoe on the sides. The Sweep comes in 8, 10, 12, and 18-inch sizes. The Sweep clears the center of weeds and trash, while the Hoes eliminate the majority of hand work close to the plants.

FURROWERS (not illustrated) can be used at the front or rear of the Tractor to lay off rows for planting. Also, many users find the Furrowers good tools for digging potatoes. For smaller furrows, seven-inch Shovel Steels are available; these can be used to lay off small seed crops and for center row cultivation.

POWER BARROW

The Gravely Power Barrow, which attaches to the front of the Tractor, handles heavy loads fast and easily.

Dumping the Power Barrow is simply a matter of raising the Handle, arrow in Figure 36. The Hopper is balanced so that dumping can be accomplished easily from your position at the rear of the Tractor.

The only lubrication required is an occasional shot of Mobilgrease MP in the grease fittings on the Barrow Wheel and Caster.

Note: Tractors equipped with the Electric Starter must have the Battery mounted on the side when using the Power Barrow.

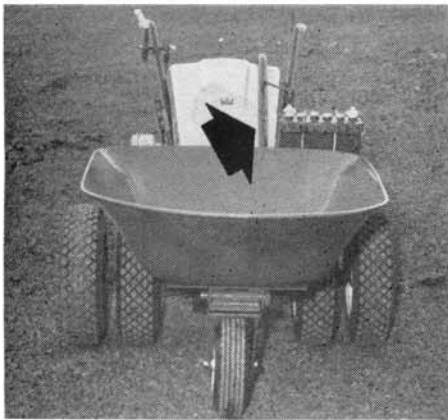

Figure 36

UTILITY SCOOP

The Gravelly Utility Scoop is a durable, efficient tool that performs a wide range of materials handling jobs for home, farm, and industry. Among its major uses are light landscaping and grading, transporting sand, gravel, and similar materials, and removing snow from walks, driveways, and parking areas.



Figure 37



Figure 38

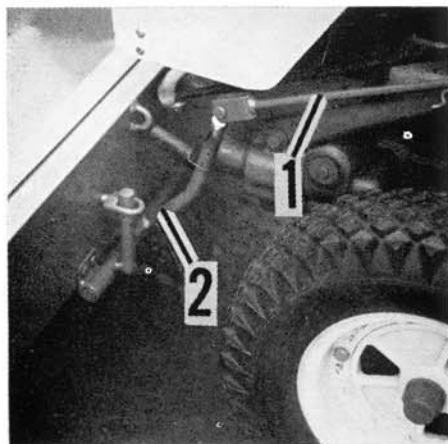

Figure 39

LUBRICATION

The only lubrication required is an occasional light application of Mobilgrease MP on the Locking Pins (which protrude through the Frame to hold the Scoop in the loading position).

ATTACHING

The Scoop is attached to the front of the Tractor by four bolts. When attaching, it must be inverted fully to the position shown in Figure 38.

To attach the dumping control mechanism, return the Scoop to the loading position. Extend the Control Linkage,

1 in Figure 39, fully, and attach it to the Locking Pin Rod, 2 in Figure 39, with the key and pin provided. Then attach the Actuating Lever, as shown in Figure 37, to the Tractor Handle, using the clamp, bolts, and nuts provided.

OPERATING INSTRUCTIONS

To load, ease the Scoop into the material until filled sufficiently. Back the Tractor off, bearing down on the Handles to raise the Scoop.

To transport, simply guide the Tractor, keeping slight pressure on the Handles to keep the Scoop elevated.

To dump, depress the Tractor Handles enough so the Scoop can be moved directly over the place where dumping is desired. Keeping the Scoop elevated, push the Actuating Lever forward to unlock the Scoop from the Frame. The weight of the load will cause the Scoop to pivot downward, emptying all contents.

Back the Tractor off, simultaneously decreasing pressure on the Handles. This drops the Scoop to the ground, locking it in the loading position.

Note: With the Scoop fully inverted as shown in Figure 38, the Scoop may be used as a blade to level dumped materials.

REAR CULTIVATOR TOOL HOLDER

To secure the Rear Cultivator Tool Holder to the Rear Hitch Frame, first line up the notches, arrows in Figure 40, with the Rear Hitch Frame cross-member to which the Ball Stud is attached. Bolt the Tool Holder to the Frame with the nuts and bolts provided.

All cultivating implements designed for the Cultivator Tool Holder fit the Rear Cultivator Tool Holder, and are attached in the same manner. Cultivating depth adjustment is the same as for the Cultivator Tool Holder.

No lubrication is required.

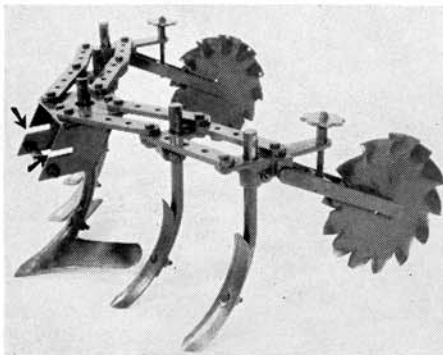

Figure 40

STEERING SULKY

The Gravelly Steering Sulky (which is shown in the 50-inch Rotary Mower photo on Page 10) lets you steer the Tractor effortlessly and comfortably. With the Sulky you steer as you would your automobile—it's that easy.

An optional Sulky Seat Cushion, made of soft foam rubber and plastic, may

be purchased from your Gravelly dealer.

Note: Dual Wheels should always be used on the Tractor with the Steering Sulky.

ATTACHING. The Sulky is bolted to the Rear Hitch Frame.

SEAT ADJUSTMENT. The Seat can be moved forward or rearward to meet your requirements. When delivered, the Seat Spring is bolted to the Sulky Frame through the middle two of four holes in the Frame.

To move the Seat forward, loosen both nuts and lift the Seat Spring from the Frame. Move both bolts forward one hole, making sure the small pulley on the rearward bolt still forces the Steering Cables to cross over. Replace the Seat Spring on the bolts, put the washers on, and tighten the nuts securely.

To move the Seat rearward, loosen both nuts and lift the Seat Spring off the Frame. Leaving the bolt which holds the small pulley in place, move the other bolt to the rear most hole in the Frame. Replace the Seat Spring, put the washers on the bolts, and tighten the bolts firmly.

STEERING CABLE ADJUSTMENT. Proper adjustment of the Steering Cables is vital for satisfactory operation. With the Sulky Wheels in line with the Frame, be sure tension on both Cables is the same. Tension is adjusted by the nuts on the end of the threaded portion of each Cable. Check this tension at reasonable intervals.

LUBRICATION. The only lubrication required is an occasional shot of Mobilgrease MP in the grease fitting on each wheel.

RIDING SULKY

The Gravelly Riding Sulky (see Sickle Mower photo on Page 9) lets you guide the Tractor easily while you ride comfortably.

An optional Sulky Seat Cushion, made of soft foam rubber and plastic, may be purchased from your Gravelly representative.

ATTACHING. The Rear Hitch and Split-Socket Connection are required.

SEAT ADJUSTMENT. The Seat can be moved forward or rearward to suit your requirements. Simply detach the Seat Spring from the Sulky Frame, move it to the desired position, and re-attach it to the Frame by the provided nuts and bolts.

LUBRICATION. The only lubrication required is an occasional shot of Mobilgrease MP in the grease fittings on the Wheels.

DISC HARROW

The Disc Harrow, not illustrated, is used mainly for cultivation, as the Rotary Plow prepares a perfect seedbed which does not require harrowing or dragging.

ATTACHING. The Rear Hitch and Split-Socket Connection are required.

PITCH ADJUSTMENT. Pitch of the Discs is adjusted by a clamp screw which actuates a rod that controls the angle of pitch.

LUBRICATION. An occasional shot of Mobilgrease MP on the Axle is the only lubrication required.

TURN PLOW

The Turn Plow, shown below, is a useful tool for breaking soil. The Rear Hitch and Split-Socket Connection are required.

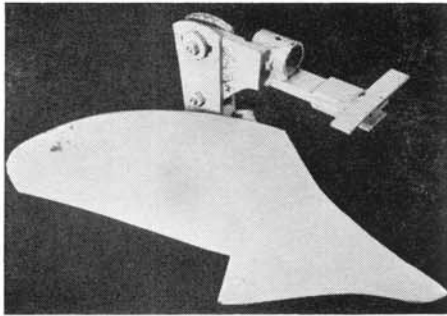

HAY RAKE

The 48-inch Hay Rake makes quick work of clearing land of cut weeds and heavy grass. It is a useful attachment for work in conjunction with the Sickle Mower.

A Lever in easy reach of the operator quickly raises or lowers the Rake.

The Rear Hitch and Roller-Rest Connection are required.

Use the method under "Securing Loaded Attachments," always to attach the Hay Rake.

No lubrication is required other than an occasional application of Mobilgrease MP to the Wheels.

Hay Rake ➡➡➡



REAR HITCH INSTRUCTIONS

Non-power attachments used on the rear of the Tractor are classified according to the manner each is secured to the Rear Hitch:

- Attachments bolted to the Rear Hitch Frame: Rear Cultivator Tool Holder and Steering Sulky;
- Attachments using the Split-Socket Connection: Disc Harrow, Turn Plow, and Riding Sulky; and,
- Attachments using the Roller-Rest Connection: Hay Rake, Lawn Roller, Transportation Cart, and 5-foot Seeder-Spreader.

When using an attachment on the rear, if you are not using an attachment on the front of the Tractor at the same time, the front of the Tractor must be protected by an Attachment Boss Cover and gasket, or the Cultivator Tool Holder (without cultivating tools).

The Attachment Boss Cover and gasket are secured to the front of the Tractor by four bolts, in the same manner as power attachments are secured.

ATTACHING REAR HITCH

The Gravelly Rear Hitch, shown in Figure 41, is attached as follows:

1. Attach the Braces, 1 in Figure 41, to the Rear Hitch Frame loosely, using the bolts, nuts, and lockwashers provided. Be sure the short twist on each Brace is down.

2. Remove the second bolt from the bottom on both Tractor Axle Housings.

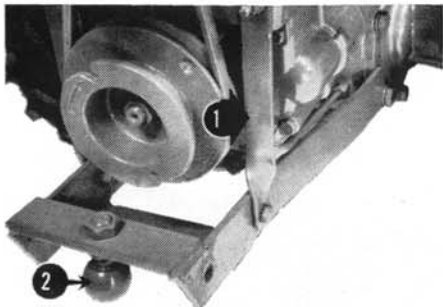

Figure 41

Slip the Frame into place, with the cross-member at the extreme end of the Frame on top. Use the two long bolts provided to secure firmly the Frame to the Tractor Axle Housings.

3. Remove the nuts from the Fan Housing, slip the Braces on, and replace the nuts. **Note:** On Tractors with Serial Numbers less than 80,000, the length of the stud on the Brackets which hold the Fan Housing to the Tractor may be inadequate if both the Rear Hitch Braces and Governor Bracket are mounted. In this case, see your Gravelly dealer for Brackets of the proper length.

4. Place the large nut on the Ball Stud, 2 in Figure 41, and run it up to the end of the threads. Screw the Ball Stud into the hole in the cross-member on the end of the Frame. Place the second nut on the Ball Stud and lock both nuts tightly against the cross-member. Be sure the Ball Stud hangs under the cross-member and not on top of it.

5. Tighten securely the nuts which hold the Braces to the Rear Hitch Frame.

Note: The bottom of the Ball Stud has an opening into which will fit a 1/4-inch Allen wrench.

LEVELING THE TRACTOR

Sometimes it is necessary to "level" the Tractor when using the Rear Hitch to keep the Handles from hitting your knees when turning. To do this, loosen the lock nuts on the Ball Stud and turn the Ball Stud (with a 1/4-inch Allen wrench) clockwise to raise the Handles (or counter-clockwise to lower the Handles).

Note: After this adjustment, be sure the lock nuts on the Ball Stud are tightened securely.

If there still is interference, loosen the rearmost bolts which hold the Handles to the Tractor, move the Handles up (or down) within the slots until the proper height is reached, and tighten the bolts securely.

SPLIT-SOCKET CONNECTION

The Disc Harrow, Turn Plow, and Riding Sulky require the Split-Socket Connection. To secure the Harrow or Sulky to the Rear Hitch, first place the Split-Socket around the Ball Stud. Next, insert the end of the Split-Socket into the hollow Draw Bar on the attachment, lining up the hole in the Draw Bar with the hole in the end of the Split-Socket. Insert the Pin through both holes.

Be sure the nuts on the Ball Stud are locked securely against the cross-member.

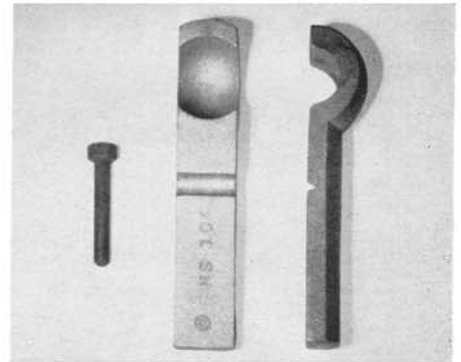

ber. These nuts, rather than the threaded portion of the Ball Stud, absorb the thrust. Unless both nuts are tightened securely, the threads in the hole in the cross-member may be stripped.

ROLLER-REST CONNECTION

The Roller-Rest Connection is used to secure these attachments to the Rear Hitch:

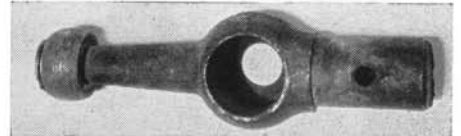

Hay Rake, Lawn Roller, Transportation Cart, and 5-foot Seeder-Spreader.

Assemble the Roller-Rest Connection by slipping the Roller over the smaller, slightly-tapered end, and securing it in place with the Retaining Ring.

SECURING UNLOADED ATTACHMENTS. To secure an unloaded attachment, place the Roller-Rest Connection so the Ball Stud fits into the opening in the Connection and the Roller rests on the lower cross-member of the Hitch Frame. While holding the Connection in this position, bring the hollow Draw Bar over the end of the Connection, line up the holes in the Connection with those in the Draw Bar, and drop the pin in place.

SECURING LOADED ATTACHMENTS. To secure a loaded attachment, secure the Connection to the Draw Bar. Bring the Tractor to the attachment, and tilt the Tractor forward enough to guide the roller end of the Connection into position on the lower Frame cross-member. Then lower the Tractor to its normal position so that the Ball Stud fits into the opening in the Connection.

Level the Tractor, if required.

LAWN ROLLER

The Lawn Roller makes easy the job of smoothing out rough places on lawns. It is 32 inches wide, has round edges to prevent lawn damage, and weighs 655 pounds when filled to capacity with water—plenty of weight to press down rough spots, but not too heavy to keep the powerful Gravely Tractor from moving it to practically anywhere you need it.

ATTACHING TO TRACTOR. The Rear Hitch and Roller-Rest Connection are required.

FILLING THE ROLLER. Move the Roller until the Filler Plug (a large brass plug on the right side of the Roller) is at its highest point. Simply remove the Plug to fill the Roller; be sure it is replaced after filling. Water generally is used.

LUBRICATION. An occasional greasing of the Axles with Mobilgrease MP is the only lubrication required. To lubricate, remove the cotter pin and slip off the large washer. Make sure both are replaced.

TRANSPORTATION CART

There's always hauling to be done—and with the Gravely Transportation Cart



Transportation Cart

you have a rugged, dependable vehicle which can handle a 1,000-pound load.

Cart sides are removable, and stakes can be substituted for hauling bulky loads, such as hay. Pneumatic Tires are standard equipment.

ATTACHING TO TRACTOR. The Rear Hitch and Roller-Rest Connection are required.

DUMPING. The Cart is dumped by releasing the Latch which holds the Cart to the Frame and tilting the Cart to the rear.

LUBRICATION. The only lubrication required is an occasional shot of Mobilgrease MP in the grease fittings on the Wheels.

5-FOOT SEEDER-SPREADER

The 5-foot Seeder Spreader is a very useful attachment for seeding large lawn areas, as well as for spreading fertilizer. Its 300-pound capacity and extra width make it an ideal means of seeding or fertilizing large areas.

ATTACHING TO TRACTOR. The Rear Hitch and Roller-Rest Connection are required.

DISTRIBUTION CONTROLS. To determine the proper distribution of seed or fertilizer, refer to the self-explanatory plate attached to the Hopper. Simply set

the Port Lever to the indicated opening to distribute seed or fertilizer properly.

CARE OF HOPPER ASSEMBLY. Many materials used in the Seeder-Spreader, especially certain fertilizers, are corrosive. Abrasives also are present. This means the protective paint soon will wear off the Port Assembly and Agitator. To protect these surfaces, wash the Seeder-Spreader thoroughly with water after using and let it dry, preferably in the sun. If you do not intend to use it again within a few days, pour a small quantity of Mobiloil along the Port Openings and work the Port Lever back and forth to distribute the oil.

LUBRICATION. Use Mobilgrease MP occasionally in the grease fitting on each Wheel.



5-foot Seeder-Spreader



Lawn Roller



LAWN SWEEPER

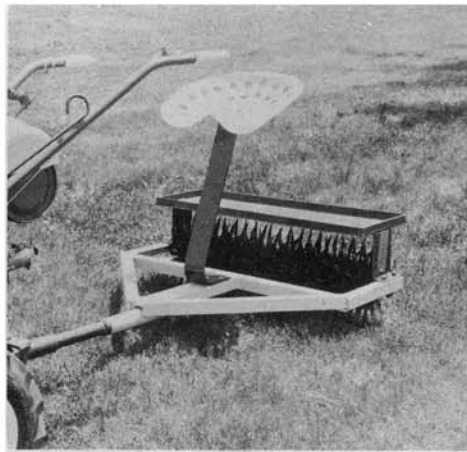

LAWN AERATOR

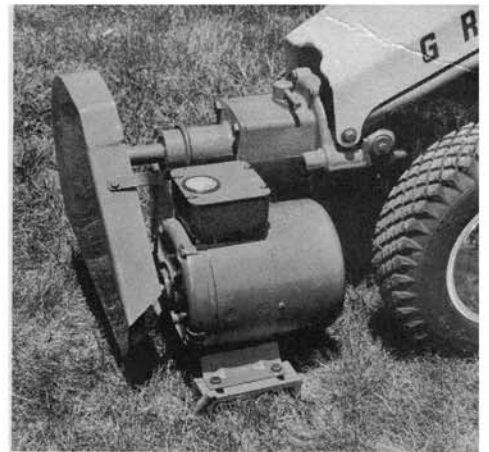

GENERATOR

SINGLE-ROW SEEDER

ADDITIONAL ATTACHMENTS FOR YOUR GRAVELY

To provide even greater versatility for you, Gravelly has arranged with other reliable manufacturers to furnish additional attachments for the Gravelly Tractor.

These attachments, some of which are shown here, are carefully adapted to Gravelly specifications, and are fully warranted by their manufacturers.

Your Gravelly dealer can obtain these special-order items for you quickly.

To keep fully abreast of the full line of Gravelly equipment, may we send you a copy of our latest four-color catalog? It's free, so write now.

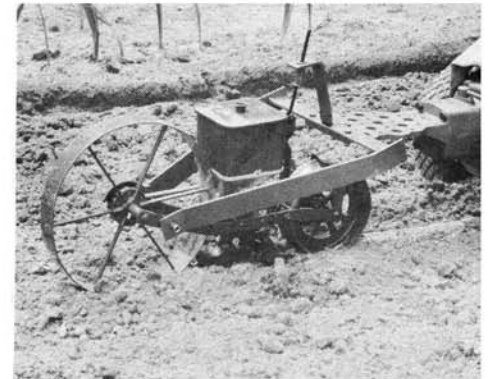

UTILITY PUMP

COMPOST SHREDDER

OWNER'S EQUIPMENT RECORD

Tractor Serial Number..... Tractor Manufacturing Number.....

Identifying Marks Other Than Above.....

Carburetor Model Number..... Magneto Model Number.....

Purchased From.....

Gravelly Representative's Telephone Number.....

EQUIPMENT LIST

Description	Model Number	Description	Model Number

Lubrication Check List

TRACTOR

RECOMMENDED OILS. Summer: Mobiloil A (SAE 30) or Mobiloil Special (SAE 10W-30). Winter (32° or below): Mobiloil Arctic (SAE 20W) or Mobiloil Special (SAE 10W-30).

OIL LEVEL. Check oil level daily before starting Engine. On Tractors with Dipstick, fill to FULL mark. On Tractors without Dipstick, fill until oil runs out Oil Level Hole.

OIL CHANGES. Change oil every 20 hours during 40-hour break-in period. After break-in, change oil every 60 hours under normal conditions, or every 40 hours under very dusty or dirty conditions. Change oil every 40 hours during extended industrial use.

OIL FILTER. Satisfactory performance is assured by changing Oil Filter according to directions every 150 hours (maximum), or once a season, whichever is shorter period. For best results change Oil Filter every 80 hours.

DOUBLE-GUARD AIR CLEANER. Inspect every eight hours under normal conditions, every four under very dusty conditions. Clean as required according to directions. Use same oil as in Tractor.

OIL BATH AIR CLEANER. Inspect daily under normal conditions and hourly under extremely dusty conditions. Clean as required according to directions. Use same oil as in Tractor.

GOVERNOR. Check oil level daily. Fill to level of Oil Check Valve. In summer use same oil as used in Tractor. In winter (32° or below) use Mobiloil (SAE 10) or Mobiloil Special (SAE 10W-30).

ATTACHMENTS

GEAR HOUSINGS. Check oil level of Gear Housings on mowing attachments every four hours. Check oil level of Gear Housings on other attachments every eight hours. Fill to required level with Mobilube EP 140 (SAE 140) on all attachments except Snowblower; fill Snowblower Gear Housing to required level with Mobilube EP 80-90 (SAE 80-90).

GREASE FITTINGS. Use Mobilgrease MP occasionally on all grease fittings except on Caster Assemblies of 50-inch Rotary Mower. Use Mobilgrease MP every 10 hours on Caster Assemblies of 50-inch Rotary Mower.

**BE SURE TO MAIL YOUR WARRANTY
REGISTRATION CARD!**
Parts and Price Lists Available on Request

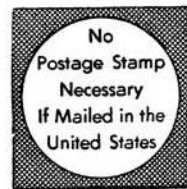
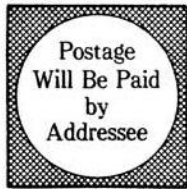

BUSINESS REPLY MAIL
FIRST CLASS PERMIT NO. 18 DUNBAR, W. VA.



GRAVELY TRACTORS DIVISION, STUDEBAKER CORP.

Dunbar, West Virginia 25064

Be Sure to mail your Warranty Registration Card Today

2½ - Gallon Gasoline Can—Yours for the names of five friends who need a Gravely!



Just what you need! The perfect gasoline can for re-fueling your Gravely. Yours for the names of five friends who need Gravely equipment. Just fill out this card and mail to us in the postage-paid envelope. Do it today!

Send Literature about the Gravely to:

- 1 Name _____
Address _____
City _____ State _____
- 2 Name _____
Address _____
City _____ State _____
- 3 Name _____
Address _____
City _____ State _____
- 4 Name _____
Address _____
City _____ State _____
- 5 Name _____
Address _____
City _____ State _____

Warranty Registration Card

Name _____
Address _____
City _____ State _____
Date purchased _____
From _____
Serial No. 2m 33482 Magneto WIC 0
Manufacturing No. 11941
Attachments Purchased: _____

I own _____ acres.
My occupation is _____
I was influenced to buy by the following:
(Check one or more).
 Magazine ads Newspaper ads TV Radio
 Gravely User Salesman's Call Fair or Show Display Demonstration
 Other: _____

DO NOT SEPARATE FOLD AND MAIL